

**Habitat suitability modelling and components of
reproductive success in the Wryneck *Jynx torquilla***



DIPLOMARBEIT

an der Philosophisch-naturwissenschaftlichen Fakultät der Universität Bern

vorgelegt von

SAMUEL EHRENBOLD

2004

Leiter der Arbeit:

Prof. Dr. R. Arlettaz,
Conservation Biology
Zoologisches Institut, Universität Bern

ABSTRACT	3
GENERAL INTRODUCTION	4
Part I: Ecological Niche Factor Analysis & habitat suitability modelling.....	7
AIMS OF THE STUDY	7
MATERIALS & METHODS.....	8
Ecological Niche Factor Analysis (ENFA).....	8
Species maps	8
Ecogeographical variables (EGV).....	11
Factor calculation	13
Habitat suitability map	13
RESULTS.....	15
Ecological Niche Factor Analysis (ENFA).....	15
Habitat suitability maps.....	17
Validation	17
DISCUSSION	21
Part II: Components of reproductive success in the Wryneck <i>Jynx torquilla</i>	23
AIMS OF THE STUDY	23
MATERIALS & METHODS.....	24
Study area and data sampling.....	24
Effects of disturbance on hatching success	25
Egg failure	25
Food availability and composition	27
RESULTS.....	28
Effects of disturbance on hatching success	28
Egg failure	29
Brooding course	29
Laying sequence	30
Food availability and composition	31
Reproductive success	32
DISCUSSION	33
CONCLUSIONS.....	36
ACKNOWLEDGMENTS.....	37
REFERENCES.....	38
APPENDICES.....	42

ABSTRACT

1. Wrynecks *Jynx torquilla* are declining in large parts of their European distribution range. In Switzerland, large parts of the Jura Mountains and the Plateau have been abandoned during the past decades. Today, Wrynecks occur regularly only in the Alps and in southern Switzerland. They breed in various semi-open habitats and feed primarily on ants *Formicidae* and their various development stages. We looked first at species habitat requirements, second at reproductive success in a nest box breeding population in southwestern Switzerland.
2. Several factors such as soil composition, temperature or rainfall have been suggested for explaining the distribution of Wrynecks. However, quantitative assessments have remained scarce. In order to understand ecological factors that dictate the distribution of Wrynecks in Switzerland, a GIS analysis was conducted.
3. The analysis showed that only few ecogeographical variables explain the distribution of Wrynecks in Switzerland. Open landscape was generally avoided, whereas landscapes with forests, fruit-tree plantations as well as vineyards were preferred. Yet, the predicted area of suitable habitat in Switzerland was obviously overestimated by the analysis. This may be due to the fact that potentially important variables such as descriptors of ant densities or bare ground surfaces were not available.
4. The decline of the Wryneck population in Switzerland may be due to decreasing reproductive success. I investigated first, laying sequence and brooding course to see how they may affect hatching probability. The brooding course was highly variable in this species, with average brooding time of about 80%. Larger non-breeding periods occurred, yet the irrelevance for hatching success could not be properly assessed.
5. Effects of investigator disturbance in our nest box population were also studied. We looked at the effect of visits frequency by the observer. The frequency of visits had a significant influence on hatching success. One visit every 48 hours reduced the probability of hatching success to 80%, one visit every 18 hours down to 50 %.
6. As food might be a limiting factor, I looked at the relationships between ant abundance and nestling diet. Wrynecks prey principally on *Lasius niger*, one of the most abundant species locally. This ant species is also abundant throughout Switzerland, which suggests that food limitation is not a problem. Yet, the availability of this prey might largely depend on the occurrence of microhabitats offering extensive surfaces of bare ground. In this respect, dense grass cover might be detrimental to Wrynecks.
7. Overall reproductive output was higher in 2003 than in 2002. This is probably mainly due to a higher number of breeding pairs in 2003. There was no significant difference between average clutch sizes, hatchling and fledgling success between the two years.

GENERAL INTRODUCTION

Distribution range and population sizes of many plant and animal species are shrinking, mostly as a direct or indirect consequence of human activities (Primack 1995). To prevent further decline of threatened species, detailed knowledge about their ecology is required (Derrickson 1998). Reasons for variation in reproductive output as well as ecological factors affecting species distribution are among the most important components to be known. Successful conservation actions ultimately depend on a thorough understanding of single species' ecology and population biology.

The Wryneck *Jynx torquilla* is a threatened declining species whose ecology is poorly understood. A continuous decline has been reported nearly over all Europe (Tucker and Heath 1994, Hagemeyer and Blair 1997). Stable populations only exist in its eastern European stronghold – the Baltic, Russia and Belarus. The Wryneck is therefore categorised as a species with 'unfavourable conservation status, but which is not concentrated in Europe' (SPEC 3) and assigned to the status 'declining' by Bird Life International (Tucker and Heath 1994).

The Wryneck is also endangered and declining in Switzerland for decades now, which renders this bird a rare and endangered species. Although still widely distributed in Switzerland during the 90's (51% of all 100 km² squares occupied), a significant range decrease could be observed during the last 20 years (Schmid et al. 1998). This range shrinkage was prominent in the Plateau and Jura, whereas the range in the Alps remained more or less stable (Schmid et al. 1998, Volet et al. 2000). However, novel data show a decline even in areas of the Alps with more traditional extensive farming (Schmid et al. 2001). In 1996, the Swiss Wryneck population size was estimated at about 2'000 - 3'000 breeding pairs. The Wryneck is categorised as 'vulnerable' on the Swiss red list (Keller et al. 2001) and it figures on the new 'priority birds list' of bird species of Switzerland for which specific action plans are in preparation (Keller and Bollmann 2001, Bollmann et al. 2002).

Today, distribution is mainly limited to the Cantons of Valais, Ticino and Grisons where Wrynecks occur from less than 400 to nearly 2000 m altitude. Wrynecks breed in various types of semi-open landscapes. Typical are small woods and pastures as well as intensively cultivated fruit tree plantations (lower Valais), low-intensity vineyards, orchards and parks. Wrynecks are long-distance migrants; they arrive in Switzerland (Central Europe) in March and April and leave between August and September (Winkler 1999). Holes in trees as well as nest boxes are used as breeding sites (Glutz Von Blotzheim and Bauer 1980). The clutch size is large (7-11 eggs) and mortality is probably quite high during the post-fledging

period (Glutz Von Blotzheim and Bauer 1980, Cramp 1985). Infertile eggs occur frequently (pers. obs.). Incubation takes 12-14 days. Egg laying occurs in the early morning, but time lag between egg laying events is regularly longer than 24 hours (Glutz Von Blotzheim and Bauer 1980). Disturbed chicks respond to intruders with characteristic snake-like head movements and hissing. Fledging occurs after 18-22 days and young are independent 7-14 days after fledging (Glutz Von Blotzheim and Bauer 1980, Del Hoyo et al. 2002). Young birds tend to return in spring to the vicinity of their birthplace, and breeding dispersal seems to be low (Peal 1972, Berndt and Winkel 1987).

Wrynecks are specialized insectivores, primarily searching for the larvae and pupae of ants in grassland habitats (Glutz Von Blotzheim and Bauer 1980, Tucker and Heath 1994, Freitag 1996). The main prey in Switzerland are *Lasius sp.*, *Tetramorium caespitum*, *Tapinoma sp.*, *Myrmica sp.* and *Formica sp.* (Freitag 1996, Freitag 2000, Freitag et al. 2001). In Germany, Wrynecks feed on the most abundant ant species present in the habitat (Seifert 1996). During bad weather and at northern localities, other insects, especially greenflies, aphids and spiders may be brought to the nestlings (Hölzinger 2001).

Several hypotheses have been proposed to explain population and range decline. Presumably the main cause is a reduced abundance or availability of ants in grassland due to agricultural intensification (Hölzinger 1987, Bitz and Rohe 1992). Harsh weather conditions may also play a role (Bitz and Rohe 1992).

Wrynecks avoid both areas with intensive agriculture (meadowland, cropland) and maritime climates (Hagemeijer and Blair 1997). It is, however, unknown, which of these two factors (climate and habitat) is more important for the shrinkage of Wryneck distribution. Other reasons suggested are a shortage of nest sites due to modern forestry management techniques, which remove hollow trees (Hölzinger 2001). Furthermore, habitat destruction and persecution during migration or in the wintering area may also contribute to the decline (Hölzinger 1987, Freitag 1998, Sutherland 1998, Hölzinger 2001). Despite strongly correlative relationships between the factors, causal links remain unclear. For instance, climatic changes may have initiated the decline, with subsequent detrimental habitat degradation just reinforcing that phenomenon (Hagemeijer and Blair 1997, Del Hoyo et al. 2002). Key factors responsible for a general or local decline remain to be determined.

The aim of this study was twofold. First, we attempted to reveal the factors determining the distribution of Wrynecks in Switzerland through an Ecological Niche Factor Analysis (ENFA, Hirzel et al. 2002). This includes data about the occurrence of Wrynecks in Switzerland as well as several climatic and environmental descriptors, which might best

explain the observed distribution of Wrynecks. On that basis, habitat suitability map can be built. This may serve for identifying areas of higher conservation priority.

In short lived species with large litter size, such as the Wryneck, the population growth is particularly sensitive to changes in recruitment (Saether and Bakke 2000). In the Wryneck, variation in reproductive success might thus have strong effects on the population growth. Fledgling number, which is a crucial element of recruitment, is expected to be a key variable for understanding population fluctuations. We therefore looked at various components of reproductive success. As our study population breeds primarily in nest boxes, which are regularly checked, we investigated the effect of nest box control on breeding success, in particular on hatching rate, which directly influences reproductive output (Götmark 1992). We also looked at brooding attendance (Heer 1999) and parents' nutritional constraints (Bolton et al. 1992, Nager et al. 1997). More specifically we tested whether interruptions during incubation lowered hatching success due to egg cooling. Additionally, we controlled for a possible effect of egg laying sequence on hatching probability.

Food availability also acts on reproductive success (Korpimärki 1992, Verboven et al. 2001). We therefore investigated prey selection by comparing prey (pellets) provisioned to chicks with food abundance in the foraging grounds.

The results of this study may help understanding Wryneck's habitat requirements and potential distribution in Switzerland, as well as components of reproductive success. This will eventually lead to develop a targeted conservation plan in the future.

Part I: Ecological Niche Factor Analysis & habitat suitability modelling

AIMS OF THE STUDY

Wrynecks are widely distributed over the western Palaearctic. Breeding habitats consist of fringes, open woodlands, clearings, parks, orchards and gardens. Based on current knowledge, Wrynecks need basically two key resources: ground-dwelling ant prey and a breeding cavity. Species' main prey is more abundant in warm and dry soil and bare ground habitats are more easily exploited (Cramp 1985, Freitag 1998). Distribution appears then largely limited by soil composition and ambient temperatures (Glutz Von Blotzheim and Bauer 1980). In Switzerland, Wrynecks breed in many different habitats such as e.g. vineyards, open forests, orchards or parks, occurring from less than 400 m to more than 2000 m elevation (Schmid et al. 1998). A quantitative assessment of the habitat of Wryneck is still lacking, however. Therefore, we performed a GIS analysis to fill up this gap, using the database of the Swiss Ornithological Institute.

The Ecological Niche Factor Analysis (ENFA) computes suitability functions by comparing the ecological variables (EGV) where the species is present with that of the same variables over the whole set of cells within the reference area. An advantage of this approach is that only presence data are required. Compared to the often used logistic regression approaches (e.g. Tobalske and Tobalske 1999), this avoids potential bias due to false negatives (Hirzel et al. 2002). The model is based on Hutchinson's concept of the ecological niche (Hutchinson 1957). A basic tenet of the niche theory is that fitness (or habitat suitability) does not bear monotonic relationships with conditions or resources, but instead decreases from either side of an optimum. This analysis directly provides two key measurements of the niche, marginality and specialisation (Hirzel et al. 2002). By performing a habitat suitability analysis using the sighting dataset associated with a set of environmental descriptors, key environmental factors that dictate birds' presence can be identified, which is of prime importance for species protection.

More specifically, two questions were addressed. 1) Which key environmental descriptors determine the presence of Wrynecks, which might be relevant for the development of future management plans? 2) Can we define geographic hotspots for the Wryneck in Switzerland, so as to optimise efficient conservation efforts?

MATERIALS & METHODS

Ecological Niche Factor Analysis (ENFA)

The ENFA was performed using the GIS software Biomapper 2.1 (Hirzel et al. 2000). The program compares environmental descriptors of cells where the species is present with descriptors of cells of the whole study area. It computes the factors that explain most of the species' ecological distribution (similar to the Principal Components Analysis). As in the PCA, the extracted factors are totally uncorrelated (by construction), although they bear biological significance: the first factor is termed marginality factor, which describes how far the species mean is from the mean habitat in the study area, whereas the so called tolerance factors are sorted by decreasing amount of explained variance, and describe how specialised a species is by reference to the available range of variables in the whole study area. Few of the first ranked factors usually explain the major part of the whole system variance.

Our general reference area was the territory of Switzerland. It covers 41'285 km² modelled by a 100-by-100-m resolution raster map, overlaid on the hectometric Swiss Coordinate System (plane projection). Lakes, major cities and areas above 2100 m a.s.l. were excluded from the analyses because they represent unsuitable habitats for Wrynecks; this increased precision in the modelling. Yet, because the impact of environmental factors may differ among regions, further analyses were conducted on two geographic subsets: 1) The canton of Valais (southwestern Switzerland), 2) north western Switzerland, including the Plateau and the Jura Mountains.

Species maps

The Swiss Ornithological Institute provided its three observation databases, which differed qualitatively and quantitatively: 1) Information Service (IS) data, records since 1984; 2) Swiss Breeding Bird Atlas data (BVA), for the period 1993–1996 (Schmid et al. 1998); and 3) Monitoring Programme for Common Breeding Birds (MHB) data from 1999 onwards. Single data records consist of date of observation and geographic location (for more details see Schmid et al. 1998). Coordinates were rounded to the southwestern corner of their proper 1-km²-grid cell. Actual localisations were assigned to the centre of a kilometric cell by adding 500 m to each X and Y coordinate. To improve the quality of the data, these datasets were reduced using different criteria, resulting in seven different species maps A-G (Table 1).

First, only records from 1990 onwards were used so as to match the period when ecological variables were drawn. Second, all records before 1st May (optimistic version,

species maps B & E) or 15th May (conservative version, species maps C & F), respectively, were excluded. Third, all records with an Atlas Code (Sharrock 1973) of 1 (i.e. species observed during breeding period; optimistic version, species maps B & E), respectively 1 and 2 (i.e. species observed in a potential breeding habitat during breeding period) simultaneously (conservative version, species maps C & F) were excluded. Thus only observations with Atlas code 3 (i.e. singing/advertising male present during breeding period) or higher were included. Additionally, as the IS data are generally biased towards easily accessible areas of Switzerland where observer density is higher (H. Schmid, pers. com.), another data subset has been chosen, which includes only records from the BVA and the MHB (resulting in species maps A & G). The latter database results from standard surveys carried out with constant effort on study plots chosen at random. Record accuracy is here again ± 500 m. (Schmid et al. 1998, Hintermann et al. 2002).

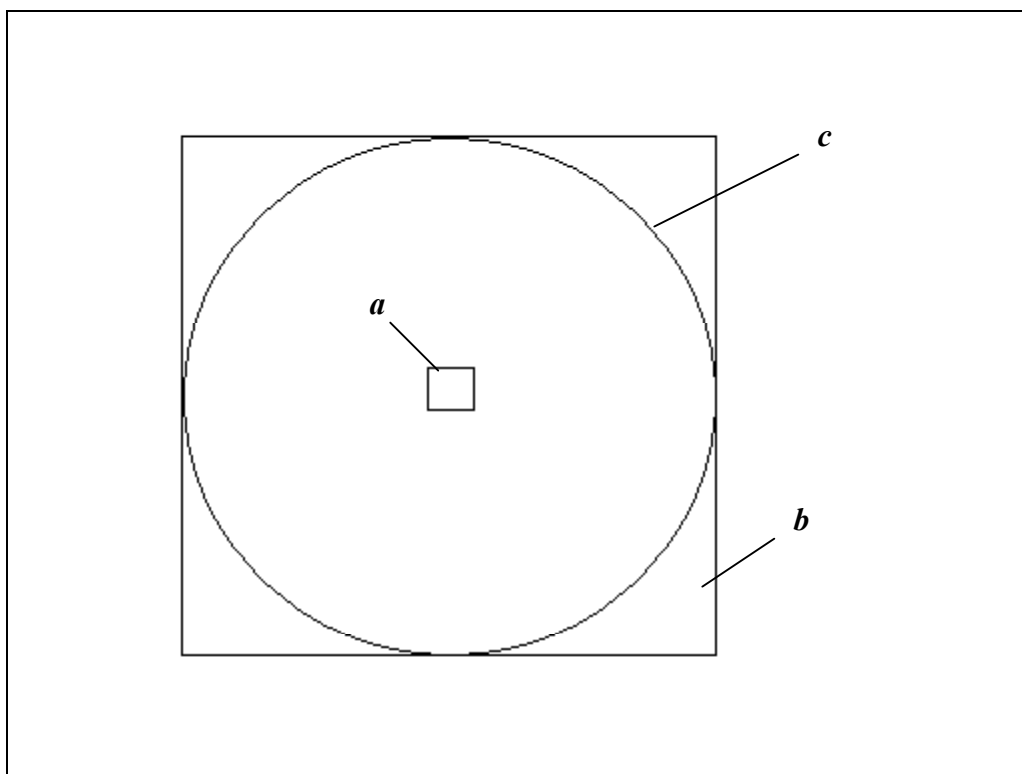

Figure 1. Scheme of species map computation. In the surveys, the observation coordinates had been rounded down to the south western corner of their proper 1-km²-grid cell (**b**). For the *hectare species maps* we assumed that the species was present in the centred hectare cell **a** and not so in the remaining area within the km²-cell. In the *buffer species maps* the species was assumed to occur nearly everywhere in the circular area **c** (0.79 km²).

Two kinds of maps were computed. On the one hand we produced maps with a quadratic cell size of one hectare (*hectare species maps*), assuming that the observation was made in the centre of the reference square kilometre. On the other hand, we drew maps with a 500 m radius circular area (buffer) around the centre of the square kilometre (*buffer species maps*), assuming Wryneck occurrence within this circular area (Figure 1). Additionally, a weighted map was computed, which weighed the observations according to their quality (date, sampling strategy, see above). Sample size ranged from 467 to 2383 records per map ($n = 7$). Fewer observations were available for the Valais and Jura and Plateau than for whole Switzerland. An overview of all species maps prepared for the ENFA is shown in Table 1.

Table 1: Species maps computed from the Swiss Ornithological databases. BVA: Swiss Breeding Bird Atlas, IS: Information Service, MHB: Monitoring Programme for Common Breeding Birds. Species observations in map D were given a weight according to quality (1 and 2, respectively). Finally, only one map was used in the ENFA.

Species map	Source	≥ Date	≥ Atlas code ¹	Kernel size ²	Sample size
A	BVA, MHB	1 st May	2	0.79 km ²	467
B	ID, BVA, MHB	1 st May	2	0.79 km ²	2383
C	ID, BVA, MHB	15 th May	3	0.79 km ²	1044
D	ID, BVA, MHB	1 st May (1), 15 th May (2)	2 (1), 3 (2)	0.79 km ²	2383
E	ID, BVA, MHB	1 st May	2	0.01 km ²	2383
F	ID	15 th May	3	0.01 km ²	1044
G	BVA, MHB	1 st May	2	0.01 km ²	467

¹ Atlas Code: international classification code for observations (Sharrock 1973):

1: species observed during breeding period;

2: species observed in a potential breeding habitat during breeding period;

3: singing/advertising male present during breeding period.

² Kernel size: circle area ($\pi*r^2$) with $r = 500$ m; square area (a^2) with $a = 0.1$ km; approximate sizes of the area where the species is thought to occur within a cell.

Ecogeographical variables (EGV)

The basic data for the ecogeographical maps was obtained from governmental organisations (Table 2). Five categories of environmental descriptors were included into the analyses: 1) topographical and geological, 2) ecological, 3) agricultural, 4) human related and 5) climate variables (Table 3).

Table 2: Sources of ecogeographical variables.

Source	official database	topic
Federal Office of Statistics	AS85R (Geostat)	Land cover
Federal Office of Statistics	DEM	Topography
Federal Office of Topography	Vector 200	Land use
Federal Office of Statistics	Landwirtschaftszählung 2000	Cattle density
WSL	Bioclim	Climate

All ecogeographical variables were rendered quantitative if necessary, by using the module *Distance* in IDRISI 32 (Eastman 2002) or the module *CircAn* in Biomapper (Hirzel et al. 2000).

Radius scale for frequency of occurrence calculations was first chosen according to the home range size of Wrynecks, which is about 200 m during the reproductive phase (Freitag 1998). However, environmental factors that influence a bird's decisions to settle on a territory might operate at larger scale. We thus arbitrarily set the radius of the circular moving window at 200 to 2000 m. Frequency of occurrence describes therefore the proportion of cells within a circle of 200 to 2000 m around the focal cell. Some maps were created using quantitative raw data (e.g. cattle density), available at the community level. When frequency maps resulted in a bad model, distance maps elaborated for the same variables were used instead. All ecogeographical maps were then masked, resulting in equally sized maps with corresponding resolution throughout the study area.

The aim was to obtain a set of EGVs potentially characterising Wryneck distribution in Switzerland. Details on all ecogeographical variables are given in Appendix 2.

Table 3: Ecogeographical Variables (EGV) prepared for the habitat analysis.

EGV	variable type
Topographical & geological	
clay	ordinal
gravel	ordinal
rocks	ordinal
slopes	continuous
elevation	continuous
Ecological	
open landscape/areas	ordinal
bushes	ordinal
forest (all types)	ordinal
open forest	ordinal
riparian forest	ordinal
riparian vegetation	ordinal
Trees & tree-like vegetation	ordinal
Agricultural	
bushy grassland & pastures	ordinal
border length open habitat	continuous
meadow & crops	ordinal
agricultural area	ordinal
fruit & wine plantations	ordinal
fruit tree plantations	ordinal
scattered fruit-trees	continuous
waste land	ordinal
cattle density	continuous
Human related	
buildings	continuous
settlement area	continuous
canals	continuous
Climate	
continentality	continuous
cloudiness May	continuous
cloudiness June	continuous
cloudiness July	continuous
cloudiness August	continuous
evapotranspiration May	continuous
evapotranspiration June	continuous
evapotranspiration July	continuous
evapotranspiration August	continuous
days with precipitation/year	continuous
precipitation May	continuous
precipitation June	continuous
precipitation July	continuous
precipitation August	continuous
average temperature May	continuous
average temperature June	continuous
average temperature July	continuous
average temperature August	continuous
water budget July	continuous

Factor calculation

If a species prefers or avoids some habitats, it is expected to be nonrandomly distributed regarding these habitat variables. The ENFA compares, in the multidimensional space of ecological variables, the distribution of ecological variables at the localities where the focal species was observed with the distribution of the ecological variables of the whole study area. The goal is to summarise a large number of potentially correlated ecogeographical variables into a small number of factors containing the major part of information. The difference between the mean (and variance) of the variables with observation, and the mean (and variance) of the variables of the whole study area is calculated and summarised by the marginality and specialisation factors, respectively. At the end, the number of factors is the same as the number of EGVs but they are then uncorrelated, with the major part of information concentrated in the marginality factor and a few of the first-ranked specialisation factors (Hirzel et al. 2002). A marginality factor that is close to one means that the species lives in a very particular habitat, relative to the reference set. Moreover, the coefficients of these ecological niche factors indicate whether the species avoids or prefers areas with corresponding characteristics. The first-ranked specialisation factors provide information on the strength of the species' dependence on a specific variable. The reciprocal of specialisation is tolerance, with a value close to one indicating high tolerance to deviations of optimal habitat.

For every species map (Table 1) an ENFA has been computed and results of the various maps were compared. The species map that gave the best model (chosen based on validation results, see below) was then used to build the final model and the habitat suitability maps.

Habitat suitability map

A habitat suitability map is calculated using the independent factors obtained by the ENFA. The suitability is defined by the probability that a given cell is occupied by the species. The approach builds on a count of all cells from the species distribution that lay as far or farther apart from the median than the focal cell on a factor axis. This count is normalised in such a way that the suitability index ranges from zero to one. An overall suitability index of the focal cell can then be computed from a combination of its scores on each factor. The number of independent factors to be included is based on MacArthur's broken-stick distribution (Hirzel et al. 2002). The accuracy of the habitat suitability maps had finally to be assessed using the Jack-knife cross-validation (Fielding and Bell 1997), which computes a

confidence interval on the predictive accuracy of the habitat suitability model. The species locations are randomly partitioned into 100 mutually exclusive but identically sized subsets. 99 partitions are used to calibrate the habitat suitability model and the left-out partition is used to evaluate it. This process is repeated several times. Two indices demonstrating the accuracy of the model are calculated. The Absolute Validation Index (AVI) is the proportion of validation points occurring in the predicted core habitat, which gives an absolute assessment of the model quality. The Contrast Validation Index (CVI) indicates how well the model discriminates unsuitable from suitable areas. A comparison of these indices allows choosing the best model (the higher the indices the better the model).

RESULTS

Ecological Niche Factor Analysis (ENFA)

The various specific maps obtained differed only slightly in explained information and the resulting habitat suitability maps. In particular, differences were only marginal when using different kernel sizes. Differences in the resulting habitat suitability maps were apparent when excluding records from the information service (IS) database. Therefore the species map *G*, which is conservative in the sense that only records from the BVA and the MHB were included (Table 1), was chosen for all subsequent analyses. Thus, 467 observations (whole Switzerland) were included in the analysis. The ENFA including all Ecogeographical Variables (EGV) showed that many variables were not relevant for the distribution of Wrynecks in Switzerland. The variables retained in the subsequent analyses are listed in Table 5. The ENFAs computed global marginality and global tolerance coefficients, which are given in Table 4.

Table 4. Three ENFAs referring to different areas modelled, with their corresponding marginality (M), specialisation (S) and tolerance (T) coefficients. Absolute Validation Index (AVI), Contrast Validation Index (CVI) and standard deviations are shown for every computation.

study area/model	M	S	T	AVI (SD)	CVI (SD)
a Switzerland	0.550	1.186	0.843	0.812 (0.071)	0.241 (0.066)
b Valais	1.166	1.901	0.526	0.804 (0.088)	0.506 (0.087)
c Plateau & Jura	0.553	1.141	0.877	0.727 (0.165)	0.211 (0.156)

The analysis giving the best results is that focusing on Valais only (AVI = 0.804; CVI = 0.506). Yet, all three ENFAs show that the Wryneck tends to avoid *open landscape*. The relatively high level of specialisation shows that it is not very tolerant regarding this factor (Table 5). The ENFA *a* and *c* revealed that the distribution of the Wryneck is negatively correlated with *agricultural areas, cattle density, meadows & crops* and *days with precipitation*. Yet the specialisation level remains low, which indicates that the Wryneck is quite tolerant regarding these variables. Two analyses (*a* and *b*) showed that the distribution is positively correlated with *fruit & wine plantations* and *forest*.

Table 5. Ecological Niche Factor Analysis (ENFA) based on the *species map G* for whole Switzerland (a), Valais (b) and Jura and Plateau (c). EGV = ecogeographical variable. Marginality factor: the symbol + means that the Wryneck was found in locations with higher values than average. The symbol – means the reverse. The greater the number of symbols, the higher the correlation. Specialisation factors: the symbol * means that Wrynecks occupied a narrower range of the ecological factor than available. Again, the greater the number of the symbol, the narrower the range. 0 indicates a very low specialisation.

(a) Switzerland

EGV	marginality (9%)	specialisation 1 (25%)	specialisation 2 (16%)	specialisation 3 (14%)
trees & tree like vegetation	-	***	***	*****
forest (all types)	+++	***	*	*
fruit & wine plantations	++++	0	0	0
agricultural areas	---	*	****	**
open landscape	-	*****	****	*
borderlength (forest/open areas)	+	**	*	*
waste land	-	**	**	*
cattle density	----	*****	*	*****
meadows & crops	--	***	*****	*****
days with precipitation	-----	**	*	*

(b) Valais

EGV	marginality (68%)	specialisation 1 (11%)	specialisation 2 (8%)	specialisation 3 (6%)
trees & tree like vegetation	++	**	**	*****
forest	++++	****	****	**
agricultural areas	++++	*	****	*
open landscape	----	*****	****	*
borderlength open landscape	+++++	*	***	**
riparian forest	++++	*	0	0
slopes	--	*****	**	**

(c) Plateau & Jura

EGV	marginality (14%)	specialisation 1 (21%)	specialisation 2 (17%)	specialisation 3 (12%)
trees & tree like vegetation	---	**	0	****
forest	----	0	0	***
fruit & wine plantations	+++++	*	0	0
agricultural areas	--	*****	*****	*
fruit tree plantations	+	*	*	*
open landscape	--	*****	*****	*
slopes	+	*	0	0
cattle density	----	*	0	*****
meadows & crops	--	*	0	***
days with precipitation	-----	0	0	***

Habitat suitability maps

The calculation of the habitat suitability maps was based on marginality and some of the first specialisation factors. The Broken-Stick-Advice was used to decide on the number of independent factors to include in the habitat suitability computation (Table 6). The three habitat suitability maps explained between 81.7% and 93.6% of the total information. These values are composed of the total marginalities and of 63.3% to 87.3% of the specialisation (Table 6). The resulting maps are given in Figures 2, 3 and 4.

According to the computed maps, the areas of high suitability for the Wryneck lay (1) in the southern Switzerland and the Alps (Grisons, Valais, Ticino and most alpine valleys) and (2) in some parts of northern Switzerland (Western Jura Mountains, Three-Lakes-Region and North-western Switzerland; Figure 4). Looking at the smaller scaled map of the Canton Valais (Figure 3), which is the better model, shows that larger areas are depicted as suitable habitat. Although many parts of the Plateau and the Jura Mountains have been abandoned during the last decades, the models *a* and *c* depict large areas as highly suitable area for the Wryneck. This is probably an overestimation of the habitat suitability area, when compared to the density map in the Swiss Breeding Bird Atlas (Appendix 1; Schmid et al. 1998).

Table 6. Factors included to build habitat suitability maps for three different areas. Total information and the percentage of specialisation explained by each analysis are given.

HS map	modelled area	factors included	explained information %	specialisation %
a	Switzerland	4	81.7	63.3
b	Valais	3	93.6	87.3
c	Plateau & Jura	4	81.8	63.5

Validation

The Jack-Knife Cross Validations gave mean Absolute Validation Indices (AVI) between 72% and 81 % and mean Contrast Validation Indices (CVI) between 21% and 50% (Table 4). The relatively low CVI show that the analyses did not differentiate very well between suitable and unsuitable habitat. The relatively high AVI indicate that the habitat suitability maps were quite good to predict presence of Wrynecks.

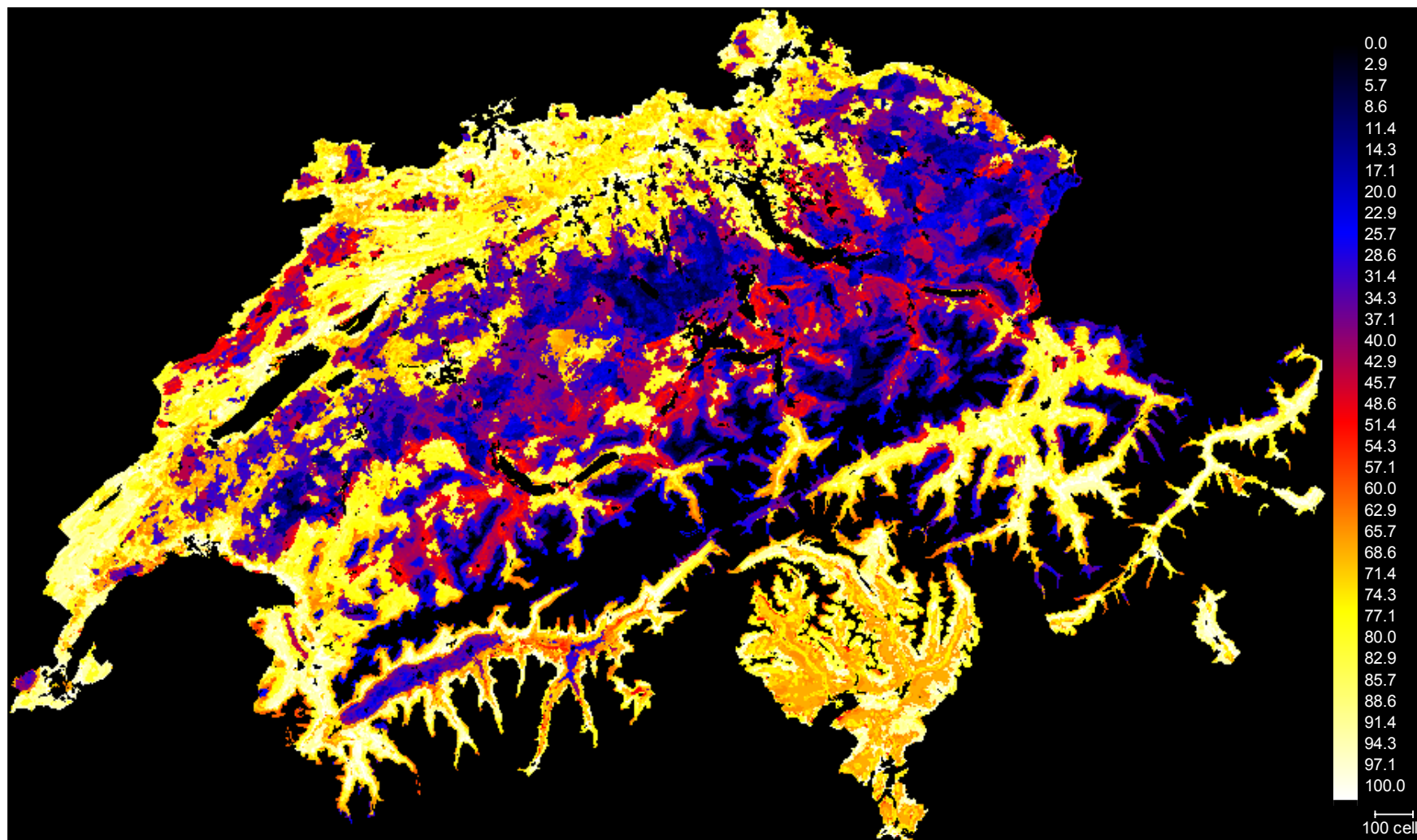

Figure 2. Habitat suitability map for whole Switzerland. Scale: low to high suitability (0 – 100%).

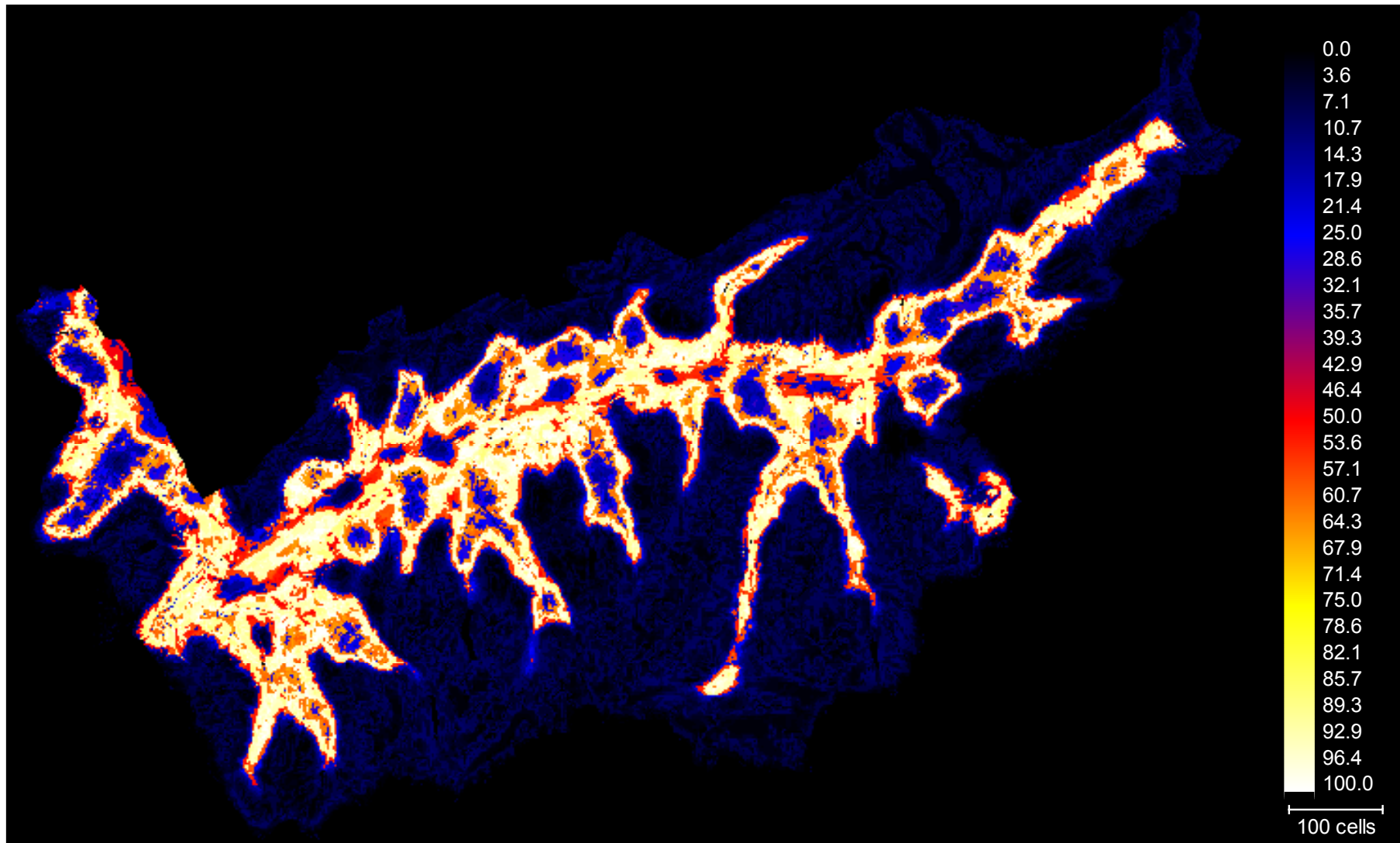

Figure 3. Habitat suitability for Valais. Scale: low to high suitability (0 – 100%).

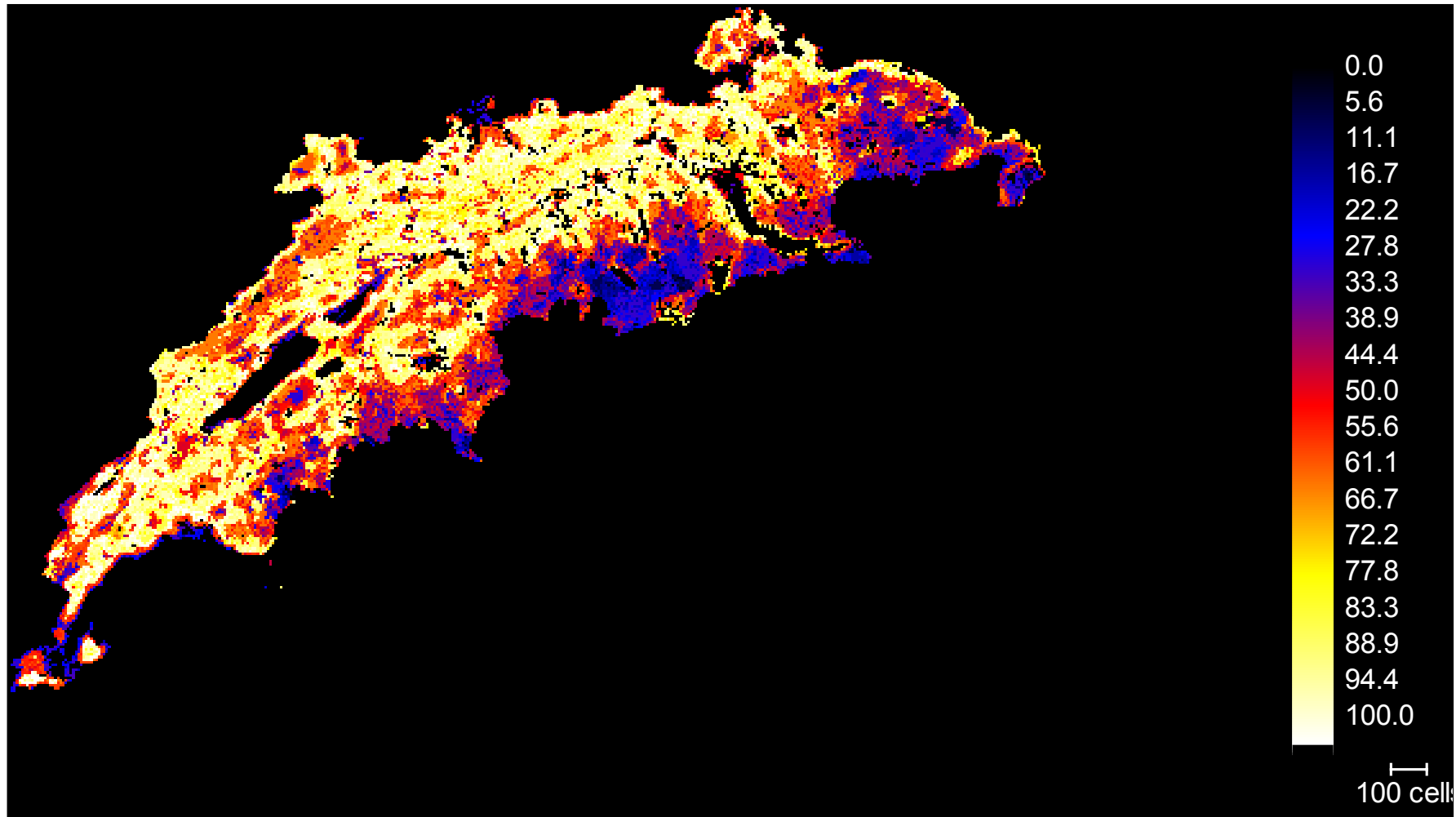

Figure 4. Habitat suitability map for Plateau and Jura Mountains. Scale: low to high suitability (0 – 100%).

DISCUSSION

The Ecological Niche Factor Analysis (ENFA) relies on presence data only, which is a great advantage when the focal species is very secretive. Therefore it was appropriate for the purpose of our study. Additionally, this analysis is generally quite robust to quality and quantity of presence data (Hirzel et al. 2001) but assumes that the detection probability is not habitat specific.

All marginality values were relatively low, which indicates that the distribution of Wrynecks in Switzerland is not limited to a very narrow range of habitats. Additionally the species is quite tolerant to departures from its optimal habitat. The analysis shows that many of the variables considered were not relevant for the distribution of Wrynecks in Switzerland. When considering Valais only (best model), it appeared that factors that affected the distribution negatively were *open landscape*, *agricultural area*, *cattle density* and *days with precipitation*. The first two factors mentioned correlate with each other since agricultural landscapes are mainly open landscape with only few vertical structures. Only the first factor mentioned above was consistent over all three models. *Days with precipitation* was the only climatic variable retained in the analyses, but note that climate variables were not relevant for the distribution of Wrynecks in Valais. Contrastingly, regional weather severities (draughts or heavy rainfalls) can reduce food availability, foraging success and therefore breeding success in Wrynecks (Bitz and Rohe 1992) and other birds species (Newton 1998). *Fruit & wine plantations* and *forest* are factors that influence the distribution positively. Higher proportions of bare ground in vineyards and fruit tree plantations, which may offer better microhabitats, with a higher accessibility of ants, or more cavities, respectively, may explain this.

The best habitat suitability modelling was drawn for Valais. A smaller reference area could at least partly explain this, since the variance of estimations declines with declining study area. Modelling Plateau and Jura (*c*) resulted in a slightly worse model than the whole Switzerland model (*a*). The reasons for this remain unclear. As the numbers of data points were quite high throughout all models, the sample size was probably not the reason for the different results. Generally, the habitat suitability analyses did not discriminate good from bad habitat very accurate, which is probably mainly due to (1) the broad niche occupied by Wrynecks or (2) missing environmental predictors, e.g. ant abundance.

According to literature, Wrynecks' breeding habitats consist of fringes, open woodlands, clearings, parks, orchards and gardens. The importance of ants in the diet leads to a frequent occurrence on warm dry ground, either bare or with short herbage; the presence of

such foraging areas as well as of suitable nest holes is critical for breeding habitat selection (Cramp 1985, Hagemeyer and Blair 1997). The distribution is limited by regionally varying factors such as soil composition, average temperatures or exposition (Glutz Von Blotzheim and Bauer 1980). In Switzerland, Wrynecks breed in many different habitats such as vineyards, open forests, orchards or parks, ranging from 200 to 2000 m a.s.l. (Schmid et al. 1998). This shows that Wrynecks inhabit a broad niche, which makes the distribution modelling over a large scale very difficult.

Additionally, the presence is tied to specific microhabitats that could not be mapped in this study, and Wryneck's distribution may depend on relatively few parameters. As a result, weak modelling might be due to missing ecogeographical descriptors being important for the Wryneck, e.g. an estimator of *percentage of bare ground proportion*. Also a variable quantifying the *offer of natural or artificial cavities*, which is a crucial factor for secondary cavity breeders, is missing. Our Wrynecks prefer forested areas and avoid open landscapes, which supports the results of a former study on habitat requirements (Tobalske and Tobalske 1999).

The areas of high suitability for the Wryneck lay in southern Switzerland, including the Alps (Grisons, Valais, Ticino and other alpine valleys), and in some parts of northern Switzerland (Western Jura Mountains, Three-Lakes-Region and North-western Switzerland). Compared to the observed distribution (Appendix 1, Schmid et al. 1998), our results confirm the presence of Wryneck's strongholds in southern Switzerland, where generally a very good habitat suitability was predicted. In northern Switzerland, large areas, which are predicted as suitable are actually abandoned. For future research, a habitat analysis should focus on smaller areas and integrate additional, micro-scaled ecogeographical descriptors (e.g. ant density, open ground), which may then deliver better models.

An additional source of variation was the lack of precise location of nesting places (accuracy: 1 km²). Wrynecks occupy relatively small home ranges and often occur in small densities. Modelling distribution with an accuracy of 1 km² may lead to underestimating the significance of small habitat patches.

Due to a lack of fine-grained habitat suitability mapping, the present analyses have only limited relevance for conservation. A new series of analyses that include small-scaled and fine-grained variables would be necessary for building maps that would enable one to clearly envision microhabitats and ecological requirements in the Wrynecks, which would then enable one to suggest appropriate conservation measures.

Part II: Components of reproductive success in the Wryneck *Jynx torquilla*

AIMS OF THE STUDY

Reproductive success in birds is determined by the number of broods and the productivity per brood (Lack 1966). Reproductive success can vary with food availability (Siikamaki 1998, Verboven et al. 2001), timing of reproduction (Reese and Kadlec 1985, Wiktander et al. 2001), age of parents (Finney and Cooke 1978, Reese and Kadlec 1985, Pärt 2001), density (Reese and Kadlec 1985) and many other factors. The overall reproductive success comprises different components, each of which may respond differently to environmental variability. The decline of the Wryneck population in Switzerland may be due to decreasing reproductive success.

Since several years, a small Wryneck population has settled down in nest boxes installed for an endangered population of Hoopoes *Upupa epops* in Valais (south-western Switzerland). Yet, these nest boxes are regularly checked and it's not known whether nest box monitoring can be responsible for the low hatching rate observed in the local Wryneck population. As a matter of fact, it has been shown that human disturbance (e.g. researchers), i.e. human activity that causes a change in metabolism and/or behaviour of an animal, can produce long-term effects on individuals and populations (Götmark 1992). We first tested for an effect of disturbance on hatching success, which might be essential to a long-term research on population dynamics. More specifically, we investigated whether investigator disturbance had a negative effect on hatching success, since incubation is generally the most sensitive period regarding disturbance (Götmark 1992).

To answer the question whether hatching success is negatively affected by prolonged breeding interruptions, the brooding course has been followed in some broods. Additionally, by marking eggs, we aimed to answer the question whether the laying order has an influence on hatching success (Potti 1993).

Second, we looked at patterns of food resource exploitation. If food resources are limited, density-dependent regulation mechanisms can be expected. The most prominent response is a decrease in reproductive success (Martin 1987, Siikamaki 1998). For studying whether food is limiting, food composition and prey selection must be unravelled. A former study carried out in Valais has shown that Wrynecks are generalist ant predators (Freitag 1996). However, this was based on a rather small sample with low generalisation power. We therefore ran a new analysis on a larger area and on more broods. We tested, whether food provisioned to chicks by parents matched ant availability.

MATERIALS & METHODS

Study area and data sampling

The study area is on the plain formed by the Rhône River between Vernayaz VS and Sierre VS (Fig.5). It has an extension of about 62 km² (1.6 x 40 km). The plain is used intensively for agricultural purposes. The main types of agricultural land use are dwarf fruit tree plantations and vineyards. Pastures, meadows and gardens are scarce. Apart along the river, tall trees are not frequent in the area, and probably the availability of natural holes is limited at least in the western part of the study area. In this area 712 nest boxes have been installed between 1997 and 2003 for a small endangered population of Hoopoe (Sierro et al. 2002). Most of them are placed in small cottages, but 55 nest boxes are in trees.

The study area has been divided into five different zones (Fig. 5). These five zones were equipped with nest boxes at different times. Nest boxes were installed first in zone A (winter 1998/99), then in zone B (winter 1999), in zone C (2000/2001), in zone D (2001/2002) and finally in zone G (winter 2002/2003). Apart from this historical development, the zones differ in habitat and resource availability (Schaub 2002, Geiser 2003).

Every second week all nest boxes in the study area have been checked for presence of Wrynecks. By using a mirror and an electric bulb the nest boxes were inspected through the entrance hole without opening the nest box. These nest boxes that were occupied have then been inspected more often (about every third day) to gather more information about reproduction (Schaub 2002).

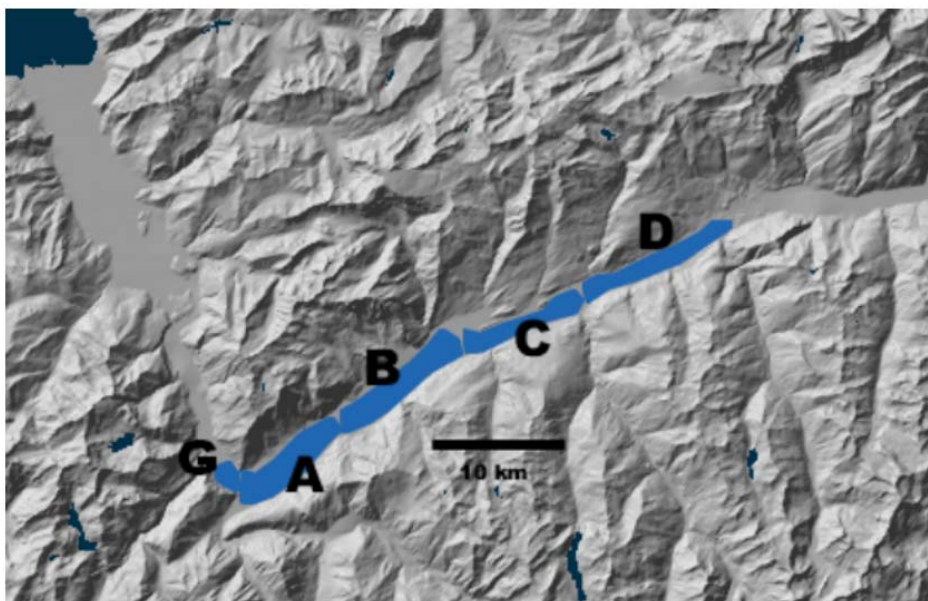

Figure 5. Rhône valley. Study site with the zones A-G (blue).

Effects of disturbance on hatching success

To compare success of nests experiencing high vs. low disturbance, broods were controlled by varying the intensity. Disturbance was defined as approaching the nest box and controlling the brood through the entrance hole with the mirror and the electric bulb. In the Wryneck, this often implies that the breeding adult leaves the nest box. It was then tested whether hatching success (success is here defined as ≥ 1 hatchling) decreased with increasing frequency of nest box visits. The disturbance intensity was the quotient of the number of visits on the disturbance exposure period (Fig. 6), the latter corresponding to the time span between the start of incubation (B) and the date of the first hatchling (H). The exact failure date had to be estimated, as it could not be recorded precisely. It was arbitrarily set at the middle date between the last day with observed ongoing incubation (C) and the first day with noticed abandonment (F). The disturbance exposure period ($b + c$) was thus calculated using the last positive control before failure (C), adding half the days of the period C-F (b) to the period B-C (c). Because the hatching success may decrease with progressing season and may differ between years and zones independently from disturbance, these factors were accounted for in the logistic regression. This resulted in more robust test for the effect of disturbance. Broods from both years 2002 and 2003 were considered ($n = 118$).

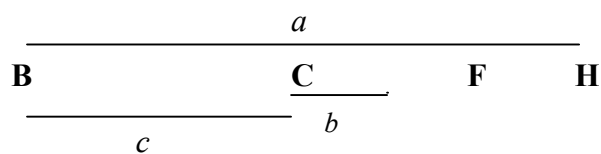

Figure 6. Schematic view of the brooding period, including the disturbance exposure period. B = day of incubation start, C = last positive control before failure, F = detection of failure, H = day of first egg hatching. Period a refers to the entire brooding period, if the date of brooding start and hatching of the first chick is known. Period $c + b$ refers to the calculated brooding period, if a failure occurred during the egg stage period (minimum conservative estimation).

Egg failure

15 broods were investigated more carefully as regards egg failure. Each egg in these nests was numbered with a waterproof pen to follow the sequence of egg laying. Sometimes, the nest could not be checked daily, resulting in several new unmarked eggs, which were all numbered equally. This approach allowed studying whether failure probability depends on the laying order. Only broods in which not all eggs hatched, but which had at least one hatchling, contained the desired information. The final sample size was thus reduced from 15 to 2 broods.

Another possible reason for egg failure may be the irregularity of brooding. To determine whether this is frequent in Wrynecks, data on timing of brooding were recorded by thermo loggers (Thermochron i-Buttons[®], Maxim Integrated Products, Inc.) that were placed among the clutch. Temperature was recorded every third minute at 7 broods. The temperature changes quickly if an adult is present (theoretically up to a body temperature of 42°C). The change of the temperature over time was then used to determine an incubation attendance. However, external factors (e.g. direct sun) may complicate pattern recognition. The following formula enabled the calculation of incubation attendance (z) from every temperature record x_i :

$$z_i = \left[\left(\frac{\sum_{i=-149}^{150} x_i}{300} * 10 \right) - \left(\sum_{i=1}^{10} x_i \right) \right] \div 10$$

Sudden rises or drops in temperature were detected using this normalising algorithm, where the mean temperature over a *large time period* (300 intervals around i) was compared to the mean temperature of 10 values at time i .

The resulting z allowed assigning a status to a given time (brooding when $z > 0$). By directly comparing temperature at a given time i with the status predicted by the formula, the brooding status was altered manually, if necessary. Additionally, the raw data was truncated at the beginning and at the end (removing 1 h) to remove any bias due to disturbance. Afterwards, one day was partitioned into eight intervals of three hours and the average incubation time over all days was used for subsequent analyses. Of 7 broods equipped with temperature loggers, brooding course could be analysed in four broods, because two were not incubated at all and another one was excluded from the analysis due to hypothesised frequent presence of humans (i.e. opening of nest box by a local farmer). Recordings started 4 to 9 (mean: 6.5) days after the first egg was laid, thus some clutches were not completed yet. As a measurement of intensity of movements at the nest, we defined *brooding changes* as half the number of visiting- and leaving-the-clutch movements, which were identified by counting the number of transitions from the incubation status to the non-incubation status.

Food availability and composition

To identify the food provisioned to the chicks, food pellets were collected using the 'ligature' method (Johnson et al. 1980). To achieve standardisation, collection was conducted only on warm and sunny days. A maximum of four chicks per brood were equipped with ligatures at a time. The other chicks were kept aside during the collection. The collection ended when the number of feedings equalled the number of ligatured nestlings; data collection never lasted more than one hour. Food pellets were stored in ethanol. In order to quantify food abundance, at least five ant nests were sampled within a radius of 200 m around the nest. The ant species were determined using standard identification guides (Seifert 1996, Della Santa 2000, Della Santa 1979).

In order to test for food selection, we compared diet composition with ant availability. We used a log-linear model (Genstat 5; Lawes Agricultural Trust 1996) with the factors *species* (7 species) and *source* (i.e. home range or food pellet, respectively).

RESULTS

Effects of disturbance on hatching success

A logistic regression with backwards elimination of non-significant effects revealed that only frequency of visits, among three factors and three interaction terms, had a significant influence on the hatching probability (Table 7). There was no seasonal effect and no difference between years. In addition, there was no significant interaction between frequency of visits and season or year. The best model including only the variable frequency of visits shows that the hatching success decreased with increasing frequency of visits ($\beta = -4.77 \pm 1.86$; Fig. 7).

The mean frequency of visits (visits/day) was $0.213 (\pm 0.149)$, whilst the average hatching success was $0.90 (\pm 0.03)$.

Predictions of hatching probability subject to frequency of visits reveals a sigmoid shaped curve (Fig. 7). The hatching probability would be $0.967 (\pm 0.019)$ in the absence of disturbance and it drops to $0.729 (\pm 0.105)$ at a disturbance level of 0.5 visits per day.

Table 7. Relationships between *frequency of visits*, *daynumber*, *year* and hatching success in the Wryneck using logistic regression ($n = 118$) and backwards elimination. Chi-Square values χ^2 , df and probabilities p of the effects are given.

	-log likelihood	χ^2	df	p
frequency of visits	4.10	8.20	1	**
year	0.27	0.54	1	n.s.
daynumber	0.05	0.09	1	n.s.
daynumber*frequency of visits	1.51	3.01	1	n.s.
daynumber*year	0.12	0.25	1	n.s.
frequency of visits*year	0.51	1.01	1	n.s.

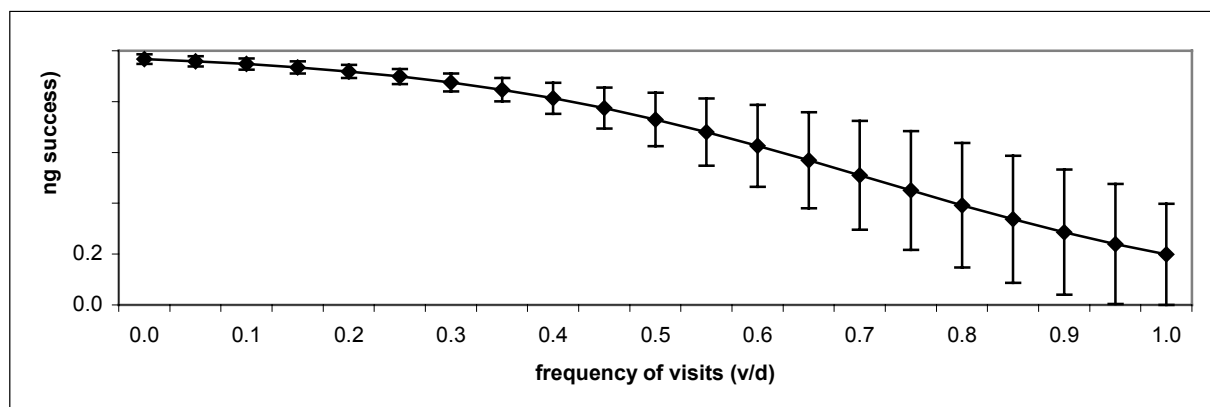

Figure 7. Predictions of hatching probability (\pm SE) subject to frequency of visits (logistic regression). Variance increases with number of visits per day (v/d) probably because sample size for high disturbance levels is low.

Egg failure

Brooding course

The total time with temperature recordings amounted to 1035 h with an average recording time of 259 h per brood (10.7 days; $n = 4$).

On average, the time spent brooding was about 80% and did not show any distinct temporal pattern, although among brood variation was large (Fig. 8). Yet, there was also a great among days variability. In some broods, the incubating bird usually left the clutch around midnight and returned in the early morning (e.g. B45). In contrast, other parents stayed on the clutch during the entire night (B14; Appendix 4).

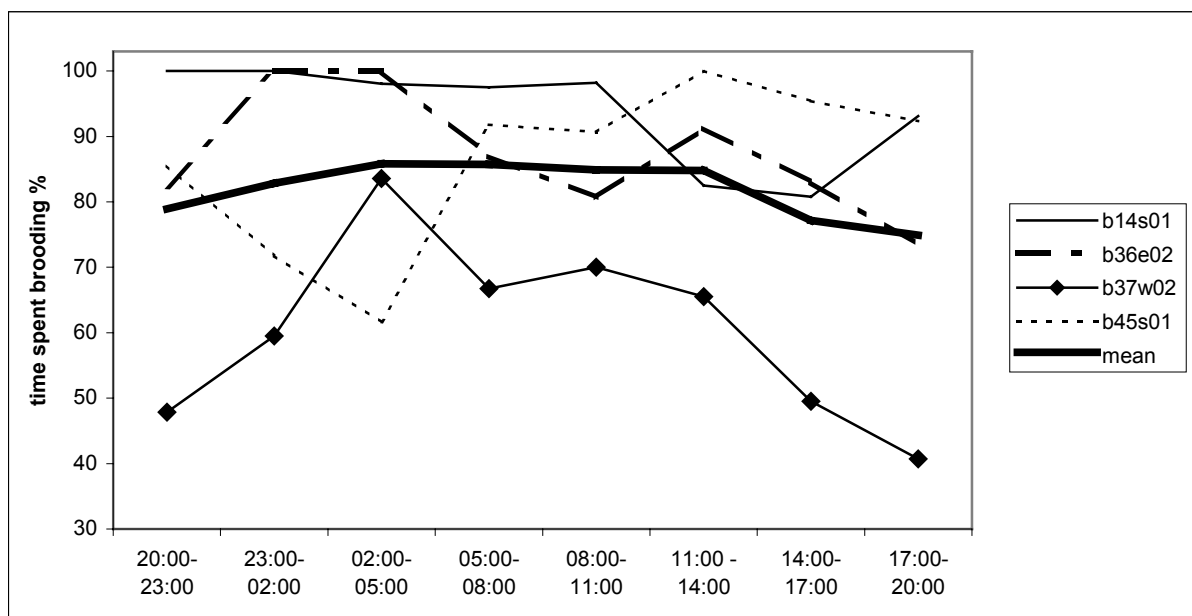

Figure 8. Time spent incubating in four Wryneck clutches. The data shown are the averages of incubation time over several days (7-12 days). The thick line refers to the average incubation time of all broods.

Furthermore I calculated the average number of *brooding changes* (i.e. 50% of visiting- or leaving-the-clutch movements, characterised by rises and drops of temperature) per 3h-interval. The number of brooding changes was highest from 5h00 to 8h00 and decreased then slightly to rise again towards 20h00. During the night, the number of movements was much lower (Fig. 9).

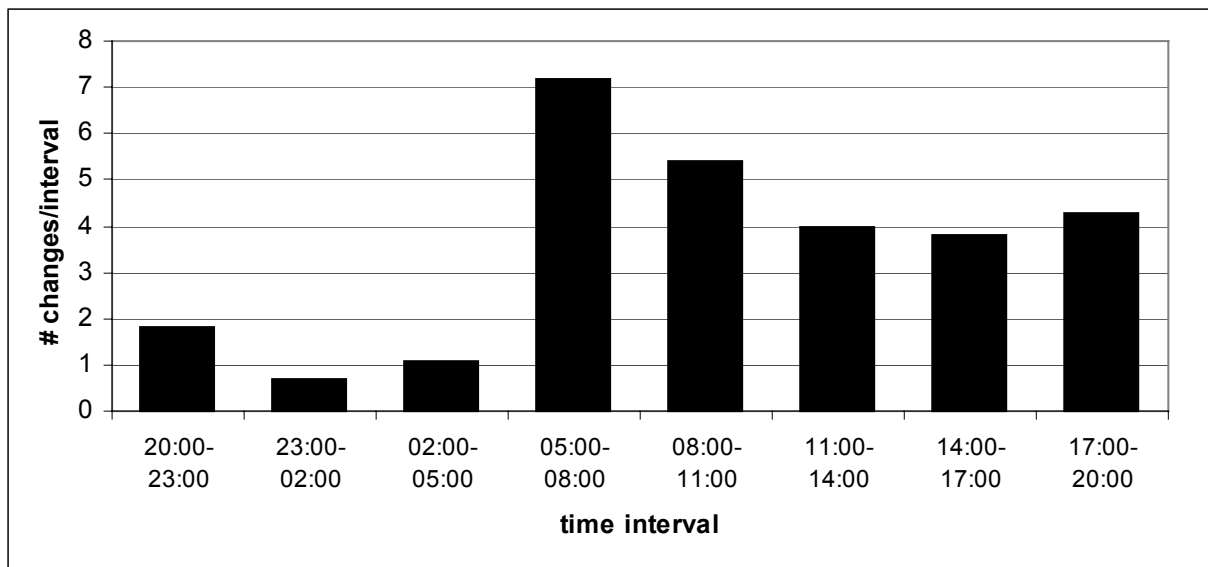

Figure 9. Number of brooding changes (i.e. 50% of visiting- or leaving-the-clutch movements, characterised by rises and drops of temperature) per 3h-interval in Wrynecks during incubation.

Laying sequence

In 15 broods 98 eggs were numbered in the order they were laid (Table 8). In two broods marked eggs ($n = 5$) did not hatch (Table 9). From these data no conclusions can be drawn about whether egg-laying order had an impact on hatching success because sample size was too low.

Table 8. Numbers of broods with eggs numbered in the order of the laying sequence. *Criteria fulfilled* = broods with unhatched eggs present after hatching of young ($n = 2$). Reasons for *disappeared* eggs are not known.

	<i>criteria not fulfilled</i>				<i>criteria fulfilled</i>		total
	no brooding	predation	disappeared	all hatched	hatched	unhatched eggs	
# broods	4	2	6	1	2		15
# eggs	20	16	36	10	11	5	98

Table 9. Broods that fulfilled the criteria ($n = 2$) and the number of eggs collected ($n = 5$). *Marking* refers to the number assigned to an egg in the order it was laid.

brood	eggs	hatchlings	fledglings	eggs collected	marking
B36e02	6	2	0	4	1,1,1,3
B45e02	10	7	4	1	1

Food availability and composition

25 food pellets from 13 broods have been collected. 23 food pellets (85 %) contained only *L. niger* and 2 contained *L. niger*, and *L. flavus* or *T. caespitum*, respectively. 65 ant nests have been found in the home range of these 13 broods. *L. niger* was found in every home range (mean proportion: 86%; range: 17-100%). The ant species provided to the nestlings did not differ from their abundance ($\chi^2 = 0.142$, $df = 3$, $p = 0.986$), indicating that Wrynecks prey upon the most abundant ant species (Fig. 10). In an additional model it was tested whether the result was consistent among zones. Hereby, three species (*L. niger*, *L. flavus* and *other*) and three zones (*A*, *B* and *other*) were considered because of the small sample size. There was no difference between zones (Table 10), i.e. the above result was consistent among zones.

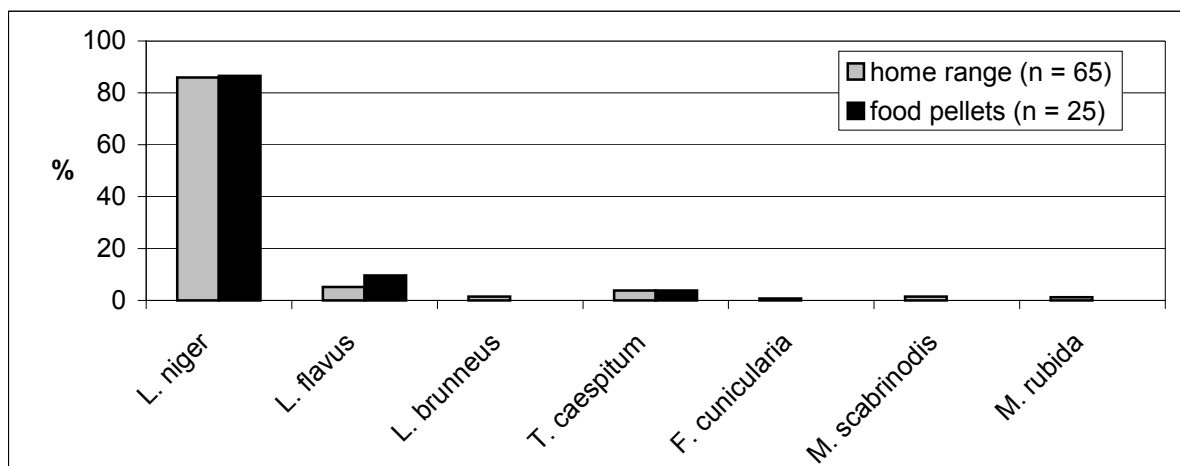

Figure 10. Percentages of ant species in food pellets (diet) and home range (availability) at 13 broods (descriptive graph).

Table 10. Comparison of species composition in food pellets (diet) and in the home range (availability) of Wrynecks (log linear model). Chi-square values, degrees of freedom (df) and associated probabilities for the factors *species*, *source* (diet, availability) and *zone* and their interactions are given.

	χ^2	df	p
Source*zone	1.458	2	n.s
Species*zone	0.309	4	n.s
Species*source	1.584	2	n.s
Species*source*zone	0.191	4	n.s.

Reproductive success

81 broods, where clutch size, number of hatchlings and fledglings were exactly known, were included in an overview of reproductive success in 2002 and 2003. Clutch size (2002: 8.07; 2003: 7.56) was not significantly different in both years (t-test: $t = 0.810$, $df = 79$, $p = 0.420$). Also the number of hatchlings and the number of fledglings was not different in the two years (hatching: t-test, $t = -0.103$, $df = 79$, $p = 0.918$; fledglings: t-test, $t = 0.140$, $df = 79$, $p = 0.889$).

Table 11 summarizes the reproductive outputs according to zone and year. Although no significant differences have been found between years as regards average breeding parameters, the overall reproductive success in 2003 was higher, due to a higher number of breeding pairs (2002: 72 broods; 2003: 90 broods).

Mean percentage of failed eggs in successful broods with correct egg and hatchling numbers was 21% in 2002 (0 - 83%, $n = 23$) and 14% in 2003 (0 - 62%, $n = 19$). The logistic regression revealed a significant effect of the factor year (model without year significantly worse: $\chi^2 = 4.099$, $df = 1$, $p = 0.042$).

Table 11. Reproductive parameters with respect to study zone (A-G, see Fig. 5) in 2002 and 2003.

	A		B		C		D		G	Total	
	2002	2003	2002	2003	2002	2003	2002	2003	2003	2002	2003
# broods	32	50	33	28	3	6	4	4	2	72	90
# broods successful	17	31	22	18	2	6	2	2	1	43	58
# broods failed	15	19	11	10	1	0	2	2	1	29	32
# eggs	270	377	274	241	23	49	22	22	23	589	712
<i>mean</i>	8.4	7.5	8.3	8.6	7.7	8.2	5.5	5.5	11.5	8.2	7.9
# hatchlings	153	228	170	166	12	42	10	17	23	345	476
<i>mean</i>	4.8	4.6	5.2	5.9	4.0	7.0	2.5	4.3	11.5	4.8	5.3
# fledglings	121	188	133	123	10	37	7	7	9	271	364
<i>mean</i>	3.8	3.8	4.0	4.4	3.3	6.2	1.8	1.8	4.5	3.8	4.0

DISCUSSION

Disturbance at nest, for instance induced by an investigator, might be a factor reducing reproductive success (Götmark 1992, Hill et al. 1997). Thus, to avoid biased results, it is important to know whether research activities influence reproductive parameters negatively. When disturbed in an early stage of brooding (nest building, egg laying, incubation) most species are more likely to abandon the brood than when disturbed in later stages (Götmark 1992). In this study, investigator disturbance had a significant influence on hatching success (i.e. the most sensitive stage) and therefore presumably on overall breeding success. Our sampling design, using varying disturbance frequency, was appropriate for our aims. The seasonal variation in sensitivity to disturbance was not significant. Control nests were disturbed on the day they were found, but not later on, which is therefore not a true control from a statistical viewpoint. Species belonging to different orders seem to differ in their degree of vulnerability to disturbance (Götmark 1992, Hill et al. 1997). Generally, disturbance may have a direct effect (birds may abandon their brood) or indirect effects (predation could increase simply because eggs or young are not attended for some time after disturbance). Cavity breeders may not be affected as much as open ground breeders, because predation risk is higher in open ground nesters and they may be more sensitive to disturbance. This might explain, at least partly, the low sensitivity of Wrynecks regarding investigator disturbance. Indeed, hatching success was still at 70%, even when disturbing every other day. Moreover, the duration or strength of disturbance did not vary, which also could be a factor determining hatching failure (Hill et al. 1997). In one particular case we assume that a higher degree of disturbance (frequent visits and nest box opening) led to clutch abandonment and to a movement to another nest box, although other possible reasons (e.g. intraspecific competition, predation) cannot be excluded. As sudden departures could damage eggs, the approach to the nest sites should be slow and in full view of the birds, giving them an opportunity to detect one's presence and leave the nest box in an orderly fashion.

Percentage of failed eggs in successful broods with correct egg and hatchling numbers is higher in our Wryneck population when compared to percentages found in literature (about 10%; Koenig 1982). As often many eggs do not hatch in the Wryneck, the question whether the frequency or duration of brooding influence the hatching success, was studied. Although longer brooding interruptions occurred, there is no evidence of a lowered hatching success due to longer brooding interruptions. The temperature logging method used was not a good technique to investigate brooding course, because (1) ambient weather conditions also

influenced measurements, provoking incorrect assignments to brooding vs. non-brooding phases exactly, (2) downloading the measurements onto a computer required opening the nest box, which potentially resulted in an additional disturbance. Reducing measurement intervals may help solve this problem. A video recording system might prove an adequate alternative for monitoring brooding attendance. In this study we could demonstrate that breeding took about 80% of the time, that patterns of brooding were rather variable and that frequent interruptions in brooding occurred during the day. Parent exchange at clutch was not intended to follow. Thus, any noticeable interruption in the brooding course (i.e. drop of temperature) was analysed, independent of its reason. The results may depend on local conditions (e.g. orientation, distance to gravel walks). Some parents bred the whole night, whereas others left the nest box at midnight and did not return before dawn (consistent over several days within a brood). This behaviour is surprising. Yet, as the eggs hatched, a high tolerance to cooling may be inferred. Note that recordings of clutch attendance were mainly conducted in the second half of the breeding season, which may render the results invalid for the entire reproductive season. Most interruptions in incubation occurred at dusk and dawn, which might be explained with light conditions (sunrise in June is around 5h30 and sunset around 21h20). Due to the low sample size, no conclusions can be drawn from these data about how much hatching success was influenced by the time spent brooding. Heer (1999) showed that the incubation pattern of female Black Redstarts *Phoenicurus ochruros* and the Alpine Accentors *Prunella collaris* depend on ambient temperatures. During spells of cold weather, the females left their nest unattended for long time periods and the eggs cool down, but this did not influence hatching success negatively. As brooding interruptions did not affect reproductive success in this study, Wrynecks might be well adapted to cold spells as well.

Numbering eggs was used to test the hypothesis that laying order had an influence on the hatching probability. We needed a sufficient number of broods in which at least one, but not all eggs hatched. This was unfortunately not the case. Sample size was reduced due to several reasons: (1) the clutch was predated before or just after hatching, (2) after egg laying, no brooding occurred at all, (3) some eggs hatched, but the unhatched eggs disappeared (removed by parents?), and (4) all eggs hatched. This resulted in a sample size of unhatched eggs ($n = 5$) that did not allow to draw definitive conclusions. Still, in the two broods fulfilling our criteria, it tended to be the earlier laid eggs that did not hatch. Further egg marking is necessary to obtain conclusive results on this.

Wrynecks fed on ant species according to their abundance. Their most important food locally is *Lasius niger*, which corroborates former studies (Freitag 1998). In the study area,

this ant species shows a high nest density and inhabits all habitats (Seifert 1996, Geiser 2003). In other studies of the Wryneck it has been shown that other insects (e.g. aphids, caterpillars) were taken if the weather conditions were adverse (Bitz and Rohe 1992). In this study, there was no case of a food item other than ants, which was possibly mainly due to the fantastic weather conditions in 2003. Also Freitag (1998), in her study of the same population, showed that other invertebrates were brought to the nestlings rarely and probably only by chance. Wrynecks are apparently not depending on specific ant species, but may be limited by the availability or accessibility of ant nests. Bare ground or scarcely vegetated areas might offer the most optimal microhabitats (Freitag 1998, Hölzinger 2001), as they provide easy access to ant nests. Ant nest density is reduced by the excessive use of pesticides (Hölzinger 1987, Hölzinger 2001). It might also be affected by fertilizers, which cause overgrowth of formerly sparsely vegetated areas and the general rise of fattier meadows (Hölzinger 1987, Hagemeyer and Blair 1997). Additionally, meadows are currently mown more frequently than in the past, potentially affecting microclimates and ant faunas (Freitag 1996). Thus, the decline of Wrynecks may be due less to a decrease of food resources, than to a decrease in prey accessibility. As the sample unit was brood, I intended to test the factor *brood*, but this was not possible using the loglinear model, due to an insufficient sample size. Alternatively, each brood could have been tested individually.

Average pair reproductive success of our study population did not differ between 2002 and 2003. However, the number of fledglings was higher in 2003 than in 2002, which was due to a larger number of broods. The production of fledglings was higher in our study area compared to other regions. For instance, 78 broods produced 3.3 fledglings each in West Germany (Del Hoyo et al. 2002), indicating that either Wryneck's habitat in Valais is very good or that unusual weather conditions prevail there in 2002 and 2003. The collection of new data on our Wryneck population in the future will enable to understand this variation.

CONCLUSIONS

The distribution of Wrynecks *Jynx torquilla* in Switzerland (and probably throughout their range) is probably limited regionally by different factors. In our GIS study, the most important negative factors were *open landscape, agricultural area, meadows and crops, cattle density* and *days with precipitation*. The distribution of Wrynecks correlated positively with *Forest* and *fruit & wine plantations*. Although the species occupies a broad niche, microhabitat structure may contribute to determine the species' distribution on a fine scale. Sparsely vegetated areas (enhanced accessibility of ants' nests) and nesting cavities are probably the most important factors therein. A habitat selection analysis could help to improve the understanding of habitat requirements.

There is strong evidence that any disturbance elicited by the investigator influences the reproductive output of Wrynecks through negatively affecting hatching success. This may have consequences for future studies on this species, where nest box checks should be minimised.

The reason for a high hatching failure could not be found in this study. Incubation attendance was highly variable. Although long breeding interruptions sometimes occurred, there was no evidence for a lowered hatching success due to this.

Reproductive success in 2003 was similar to 2002, whereas total absolute reproductive output was slightly better in 2003, mainly due to a higher number of broods.

ACKNOWLEDGMENTS

I would like to thank all the people that supported me during the time working on my diploma thesis. Special thanks to Prof. Dr. Raphaël Arlettaz and Dr. Michael Schaub for encouraging and supervising this study. Thanks to the Swiss Ornithological Institute, especially Hans Schmid and Niklaus Zbinden for providing data and valuable comment. Thanks to Niklaus E. Zimmermann (Institut für Wald, Schnee und Landschaft WSL) for disposing the climate data bases. Thanks to Helmut Steinhöfel (Bundesamt für Statistik BFS) for providing data on the cattle density. I thank Michael Schaub, Paul Mosimann, Urs Kormann, Tinu Fischer, Peter Nyffeler, Mike Schaad, Emmanuelle Yanic, Adrian Aebischer and Patrick Patthey for the nice time at the Sarajevo tower. Thanks to all the people that helped in the field, especially Michael Schaub, Antoine Sierro, Paul Mosimann, Mike Schaad and Tom Leu. Thanks to everybody who helped with analyses and statistics, especially Michael Schaub, Alexandre Hirzel, Patrick Patthey and Thomas Sattler. I'd like to thank my family for always encouraging me. I'm most thankful to Carole Schaber, who always supported me with advice and warmth. Last but not least I'd like to thank all the conservationists, especially Tinu Fischer, Rachel Egli, Maja Baltic, Judith Zbinden, Adrian Britschgi, Sebastian Schmied, Emanuel Rey, Till Berger, Fabio Bontadina, Anni Heitzmann, Antonio Valsangiacomo and Oliver Roth.

REFERENCES

- Berndt R. and W. Winkel (1987) Brutzeit-Wiederfänge vom Wendehals (*Jynx torquilla*) im südöstlichen Niedersachsen. *Vogelwelt* 108: 58-60.
- Bitz A. and W. Rohe (1992) Der Einfluss der Witterung auf den Nahrungseintrag des Wendehalses *Jynx torquilla*. *Beitr. Landes. Rheinl. Pfalz* 15: 575-591.
- Bollmann K., V. Keller, W. Mueller and N. Zbinden (2002) Priority birds for species action plans in Switzerland. *Ornithol. Beob.* 99(4): 301-320.
- Bolton M., D. Houston and P. Monaghan (1992) Nutritional constraints on egg formation in the lesser black-backed gull: an experimental study. *Journal of Animal Ecology* 61: 521-532.
- Cramp S.I. (1985) Handbook of the birds of Europe, the Middle East, and North Africa. Vol. 4, Terns to Woodpeckers. Oxford University Press, Oxford.
- del Hoyo J., A. Elliott and J. Sargatal (2002) Handbook of the Birds of the World. Vol. 7. Jacamars to Woodpeckers. Lynx Edicions, Barcelona.
- Della Santa E. (1979) Petit Guide pratique pour la détermination des principales espèces de fourmis de Suisse.
- Della Santa E. (2000) L'identification des espèces du genre de *Myrmica* (Formicidae) de Suisse; essai de présentation synoptique. *Bulletin romand d'entomologie* 18: 169-187.
- Derrickson S.R. (1998) In: Marzluff J.M. and R. Sallabanks (1998) Avian Conservation - research and management. Island Press, Washington.
- Eastman J.R. (2002) IDRISI 32.01. Clark Labs, The Idrisi Project.
- Fielding A. H. and J.F. Bell (1997) A review of methods for the assessment of prediction errors in conservation presence/absence models. *Environmental Conservation* 24: 38-49.
- Finney G. and F. Cooke (1978) Reproductive habits in the Snow Goose: the influence of female age. *Condor* 80: 147-158.
- Freitag A. (1996) Le régime alimentaire du Torcol fourmilier *Jynx torquilla* en Valais (Suisse). *Nos Oiseaux* 43: 497-512.
- Freitag A. (1998) Analyse de la disponibilité spatio-temporelle des fourmis et des stratégies de fourragement du torcol fourmilier (*Jynx torquilla* L.), Université de Lausanne.
- Freitag A. (2000) La photographie des nourrissages: une technique originale d'étude du régime alimentaire des jeunes Torcols fourmiliers *Jynx torquilla*. *Alauda* 68: 81-93.

- Freitag A., A. Martinoli and J. Urzelai (2001) Monitoring the feeding activity of nesting birds with an autonomous system: the case study of the endangered Wryneck *Jynx torquilla*. *Bird Study* 48: 102-109.
- Geiser S. (2003) Variation der Ameisendichte im Talboden des Unterwallis. *Conservation Biology* University of Bern. 15 pp.
- Glutz von Blotzheim U.N. and K.M. Bauer (1980) *Handbuch der Vögel Mitteleuropas*. Akademischer Verlag, Wiesbaden, Frankfurt am Main.
- Götmark F. (1992) The effects of investigator disturbance on nesting birds. *Current Ornithology*. D. M. Power. New York, Plenum Press. 9: 63-104.
- Hagemeijer E.J.M. and M.J. Blair (1997) *The EBCC Atlas of European Breeding Birds: Their Distribution and Abundance*. T & A D Poyser, London.
- Heer L. (1999) Long inattentive periods in the Black Redstart *Phoenicurus ochruros* and the Alpine Accentor *Prunella collaris* during a spell of cold weather. *Ornithol. Beob.* 96: 123-130.
- Hill D., D. Hockin, D. Price, Tucker G., R. Morris and J. Treweek (1997) Bird disturbance: improving the quality and utility of disturbance research. *Journal of Applied Ecology* 34: 275-288.
- Hintermann U., D. Weber, A. Zangger and J. Schmill (2002) *Biodiversitäts-Monitoring Schweiz BDM. Zwischenbericht*. Bundesamt für Umwelt, Wald und Landschaft BUWAL. Bern.
- Hirzel A., J. Hausser, D. Chessel and N. Perrin (2002) Ecological- Niche factor analysis: how to compute habitat-suitability maps without absence data? *Ecology* 83(7): 2027-2036.
- Hirzel A.H., J. Hausser and N. Perrin (2000) *Biomapper*. Laboratory for Conservation Biology, University of Lausanne.
- Hirzel A.H., V. Helfer and F. Metral (2001) Assessing habitat-suitability models with a virtual species. *Ecol. Modelling* 145: 111-121.
- Hölzinger J. (1987) *Artenschutzsymposium Neuntöter*. Beih. Veroeff. Naturschutz Landschaftspflege Bad.-Wuertt. 48: 1-204.
- Hölzinger J. (2001) *Die Vögel Baden-Württembergs*. Bd. 2.3, Nicht-Singvögel, Pteroclididae - Picidae. Ulmer, Stuttgart.
- Hutchinson G.E. (1957) Concluding remarks. *Cold Spring Harbour Symposium on Quantitative Biology* 22: 415-427.
- Johnson E.J., L.B. Best and P.A. Heagy (1980) Food sampling biases associated with the 'ligature method'. *Condor* 82: 186-192.

- Keller V. and K. Bollmann (2001) For which bird species does Switzerland have a particular responsibility? *Ornithol. Beob.* 98(4): 323-340.
- Keller V., N. Zbinden, H. Schmid and B. Volet (2001) Rote Liste der gefährdeten Brutvogelarten der Schweiz. BUWAL-Reihe Vollzug Umwelt. BUWAL, Schweizerische Vogelwarte Sempach. 57 pp.
- Koenig W. D. (1982) Ecological and social factors affecting hatchability of eggs. *The Auk* 99(3): 526-536.
- Korpimärki E. (1992) Fluctuating food abundance determines the lifetime reproductive success of male Tengmalm's owls. *Journal of Animal Ecology* 61(1): 103-111.
- Lack D. (1966) *Population studies of Birds*. Oxford University Press, Oxford.
- Lawes Agricultural Trust (1996) *Genstat 5*. IACR - Lawes Agricultural Trust. Rothamsted.
- Martin T.E. (1987) Food as a limit on breeding birds: a life-history perspective. *Annual Review of Ecology and Systematics* 18: 453-487.
- Nager R. G., C. Rueegger and A.J. van Noordwijk (1997) Nutrient or energy limitation on egg formation: a feeding experiment in great tits. *Journal of Animal Ecology* 66: 495-507.
- Newton I. (1998) *Population limitation in birds*. Academic Press, San Diego.
- Pärt T. (2001) The effects of territory quality on age-dependent reproductive performance in the northern Wheatear *Oenanthe oenanthe*. *Animal Behaviour* 62: 379-388.
- Peal R.E.F. (1972) European ringing of the Wryneck *Jynx torquilla*. XVth International Ornithological Congress 1970.
- Potti J. (1993) Environmental, ontogenetic and genetic variation in egg size of Pied Flycatchers. *Canadian Journal of Zoology* 71: 1534-1542.
- Primack R.B. (1995) *Naturschutzbiologie*. Spektrum Akad. Verlag, Heidelberg.
- Reese K.P. and J.A. Kadlec (1985) Influence of high density and parental age on the habitat selection and reproduction of Black-billed Magpies. *Condor* 87: 96-105.
- Saether B.-E. and O. Bakke (2000) Avian life history variation and contribution of demographic traits to the population growth rate. *Ecology* 81(3): 642-653.
- Schaub M. (2002) Population ecology and conservation of the wryneck *Jynx torquilla* in the Valais - annual report 2002. Conservation Biology University of Bern. 23 pp.
- Schmid H., M. Burkhardt, V. Keller, P. Knaus, B. Volet and N. Zbinden (2001) Die Entwicklung der Vogelwelt in der Schweiz. Avifauna Report Sempach 1, Sempach.

Schmid H., R. Luder, B. Naef-Daenzer, R. Graf and N. Zbinden (1998) Schweizer Brutvogelatlas. Verbreitung der Brutvögel in der Schweiz und im Fürstentum Lichtenstein 1993-1996. Schweizerische Vogelwarte, Sempach.

Seifert B. (1996) Ameisen: beobachten, bestimmen. Naturbuchverlag, Augsburg.

Sharrock J.T.R. (1973) Ornithological Atlases. *Auspicium* 5(suppl.): 13-15.

Sierro A., M. Schaad, P. Mosimann, S. Strebel and R. Arlettaz (2002) Conservation de la huppe fasciée *Upupa epops* en Valais: suivi 2002. Station ornithologique Suisse, sous-station Valais. 32 pp.

Siikamäki P. (1998) Limitation of reproductive success by food availability and breeding time in pied flycatchers. *Ecology* 79(5): 1789-1796.

Sutherland W.J. (1998) The effect of local change in habitat quality on populations of migratory species. *Journal of Applied Ecology* 35: 418-421.

Tobalske C. and B.W. Tobalske (1999) Using atlas data to model the distribution of woodpecker species in the Jura, France. *Condor* 101: 472-483.

Tucker G.M. and M.F. Heath (1994) *Birds in Europe: their conservation status*, Cambridge.

Verboven N., J.M. Tinbergen and S. Verhulst (2001) Food, reproductive success and multiple breeding in the Great Tit *Parus major*. *Ardea* 89(2): 387-406.

Volet B., H. Schmid and R. Winkler (2000) Checklist of the Birds of Switzerland. *Ornithol. Beob.* 97(2): 79-103.

Wiktander U., O. Olsson and S.G. Nilsson (2001) Annual and seasonal reproductive trends in the Lesser Spotted Woodpecker *Dendrocopos minor*. *Ibis* 143: 72-82.

Winkler R. (1999) Avifauna der Schweiz. *Ornithol. Beob. Beiheft* 10.

APPENDICES

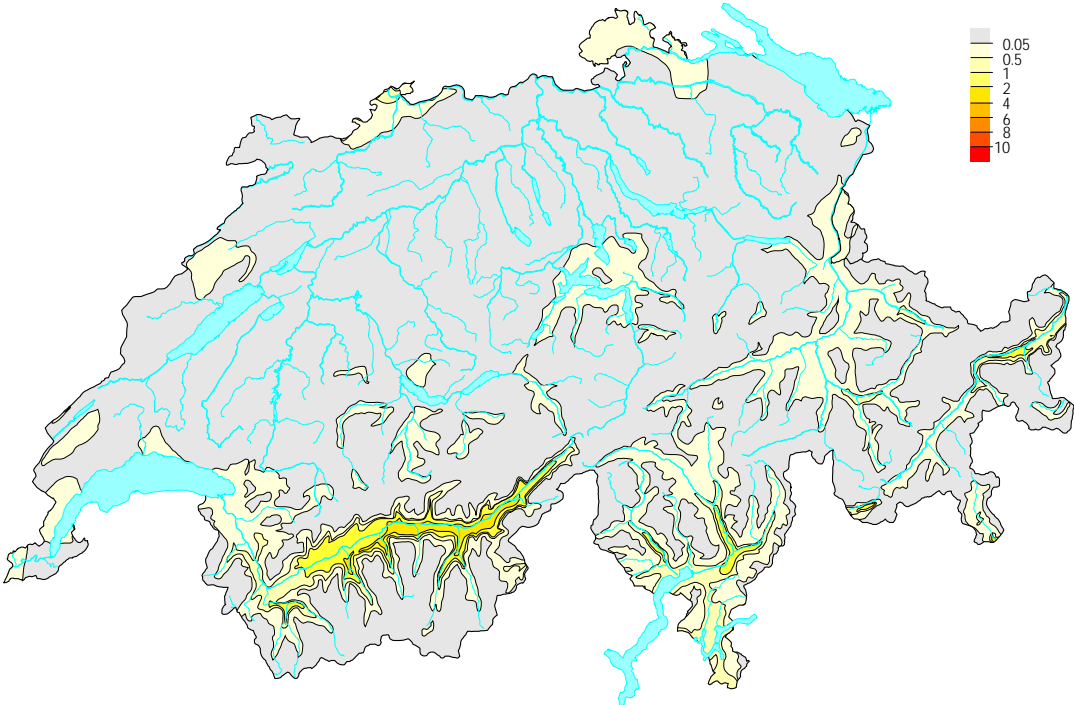

Appendix 1. Density map of Wryneck *Jynx torquilla* in Switzerland. Source: Swiss Breeding Bird Atlas 1993-1996 (Schmid et al. 1998).

Appendix 2. Ecogeographical variables (EGV) prepared for the GIS analyses. RMW = radius of the moving window for frequency of occurrence (fq) calculations.

no	EGV	Map quality	Official database	RMW (km)	Remarks
Topographical & geological					
1	clay	fq	AS85R (Geostat) ¹	2	
2	gravel	fq	AS85R (Geostat) ¹	2	
3	rocks	fq	AS85R (Geostat) ¹	2	
4	slopes	qt	AS85R (Geostat) ¹		sin & cos
5	elevation	qt	DEM ²		m a.s.l.
Ecological					
6	open landscape/areas	fq	AS85R (Geostat) ¹	2	6+12 = 100%
7	bushes	fq	AS85R (Geostat) ¹	0.5	
8	forest (all types)	fq	AS85R (Geostat) ¹	2	
9	open forest	fq	AS85R (Geostat) ¹	0.2	
10	riparian forest	fq	AS85R (Geostat) ¹	0.2	
11	riparian vegetation	fq	AS85R (Geostat) ¹	0.2	
12	trees & tree-like vegetation	fq	AS85R (Geostat) ¹	2	
Agricultural					
13	bushy grassland & pastures	fq	AS85R (Geostat) ¹	0.2	
14	border length open habitat	qt	AS85R (Geostat) ¹		Borderlength 6 & 12
15	meadow & crops	fq	AS85R (Geostat) ¹	0.2	
16	agricultural area	fq	AS85R (Geostat) ¹	0.2	Incl. 13, 15, 17, 18,19
17	fruit & wine plantations	fq	AS85R (Geostat) ¹	0.2	18+ vineyards
18	fruit tree plantations	fq	AS85R (Geostat) ¹	0.2	
19	scattered fruit-trees	min. dist.	AS85R (Geostat) ¹	0.2	
20	waste land	fq	AS85R (Geostat) ¹	0.2	
21	cattle density	qt	LWZ 2000 ³		Grossvieheinheit/Hektare
Human related					
22	buildings	min. dist.	AS85R (Geostat) ¹		
23	settlement area	min. dist.	AS85R (Geostat) ¹		
24	canals	min. dist.	Vector 200 ⁴		
Climate					
25	continentality	qt	Bioclim ⁵		
26	cloudiness May	qt	Bioclim ⁵		
27	cloudiness June	qt	Bioclim ⁵		
28	cloudiness July	qt	Bioclim ⁵		
29	cloudiness August	qt	Bioclim ⁵		
30	evapotranspiration May	qt	Bioclim ⁵		
31	evapotranspiration June	qt	Bioclim ⁵		
32	evapotranspiration Juli	qt	Bioclim ⁵		
33	evapotranspiration August	qt	Bioclim ⁵		
34	days with precipitation	qt	Bioclim ⁵		
35	precipitation May	qt	Bioclim ⁵		
36	precipitation June	qt	Bioclim ⁵		
37	precipitation July	qt	Bioclim ⁵		
38	precipitation August	qt	Bioclim ⁵		
39	average temperature May	qt	Bioclim ⁵		
40	average temperature June	qt	Bioclim ⁵		
41	average temperature July	qt	Bioclim ⁵		
42	average temperature August	qt	Bioclim ⁵		
43	water budget July	qt	Bioclim ⁵		

¹Federal Office of Statistics. AS85R, Geostat database (landcover)

²Digital Elevation Model, Federal Office of Statistics

³Landwirtschaftszählung 2000

⁴Federal Office of Topography, Vector 200 database (land use)

⁵Institut für Schnee, Wald und Landschaft (WSL), climate databases

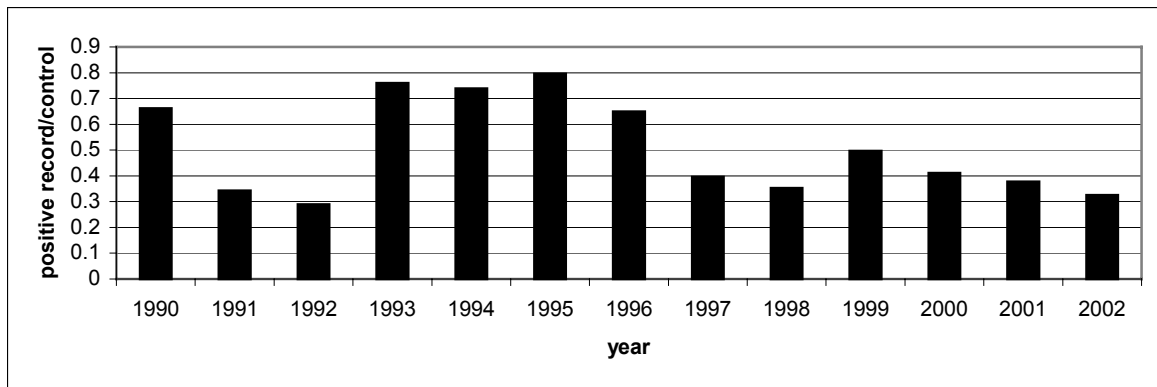

Appendix 3. Presence index of Wrynecks *Jynx torquilla* 1990-2002. The number of records per number of potentially inhabited square kilometres. Source: Swiss Ornithological Institute.

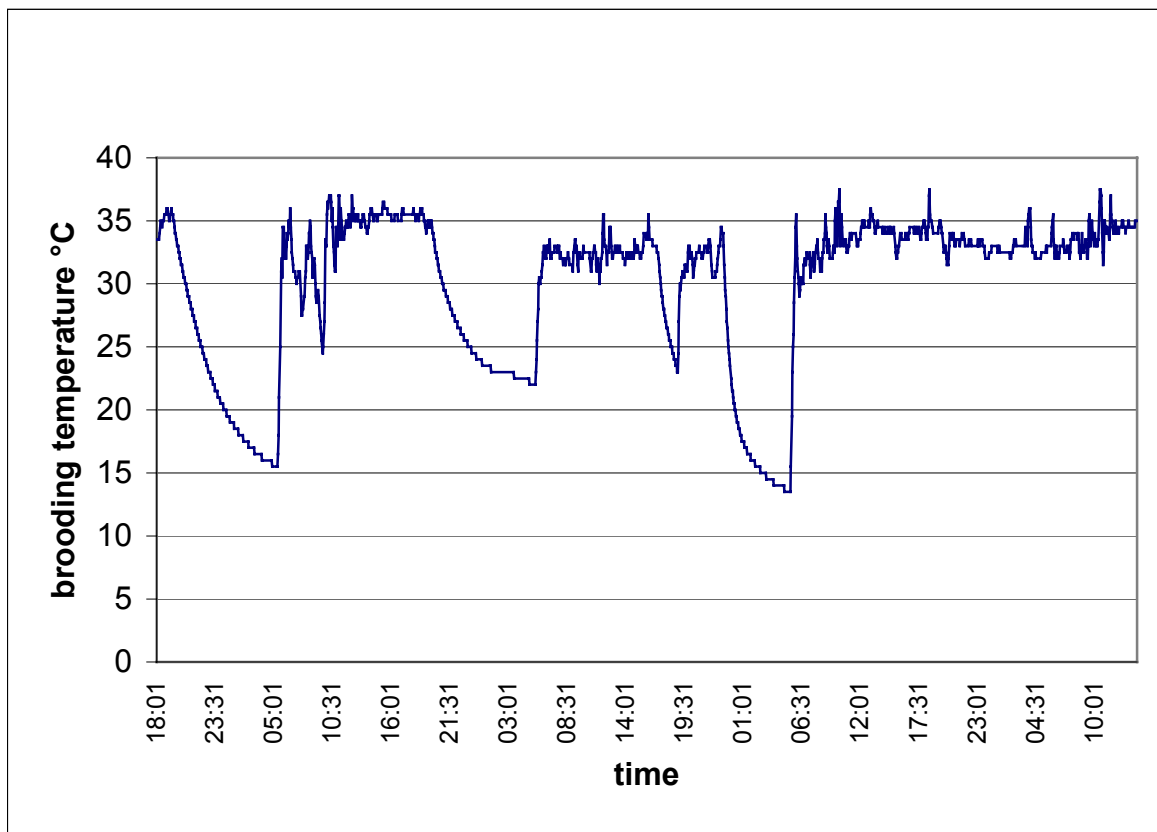

Appendix 4. Brooding course over 1839 intervals (92 h) from 29.6. – 3.7.2003 in brood B45s01.

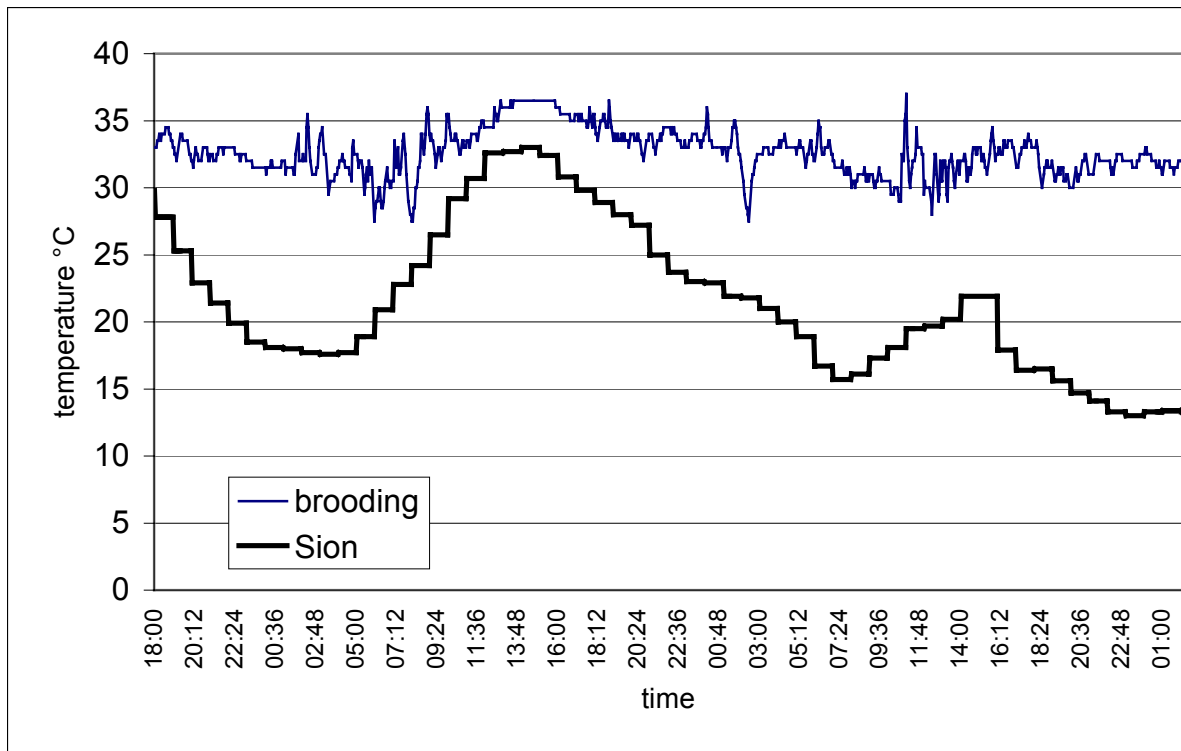

Appendix 5. Brooding course over 1239 intervals (62 h) from 29.6. – 3.7.2003 in brood B14s01.

Appendix 6. Ant species and their ecological requirements (Freitag 1998, Seifert 1996)

Lasius	niger	planar bis montan, anpassungsfähiger Kulturfolger, xerothermophil, mesophil, Städte, Parks, Gärten, Wiesen, Acker, grosse lockere, Erdhügel
Lasius	alienus	planar bis montan, sehr häufig in Wärmegebieten, Weinanbaugebiete, Trocken- und Halbtrockenrasen, xerothermophil, auch auf Kalktrockenrasen, selten auf Sand- und Kiesuntergrund
Lasius	flavus	in landwirtschaftl. und urbanen Bereichen häufigste Lasius, durch Stickstoffüberdüngung örtlich stark zurückgegangen, bevorzugt frischtrockene bis feuchte Graslandhabitate, seltener auf Trockenrasen, in Mooren, an lichten Waldrändern, erträgt auch Beweidung
Formica	cunicularia	planar bis montan, thermophile Graslandhabitate, ferner ruderale Trockenfluren, Bahndämme, mehr in hochgrasigen Lebensräumen, auf Lehmböden
Formica	cinerea	thermophile Pionierart, mineralische, kahle Rohböden, verschwinden nach vollständigem Schliessen der Bodenveg., ausgeprägt thermophil
Formica	rufibarbis	planar bis submontan, ähnlich cunicularia, aber mehr auf sandigen Böden, auf kurzgrasigen Lebensräumen mit höheren Bodentemp., weniger ruderal
Tetramorium	caespitum	planar bis collin, dominiert auf Sandböden des Tieflandes, offene, xerotherme Lebensräume aller Art, auch Siedlungsgebiet
Tapinoma	erraticum	Wärmegebiete, Trockenrasen, Kalkstein, stark besonnte, sehr trockene bis feuchte Offenhabitate auf sehr untersch. Geol. Untergrund, fehlt aber in Sandgebieten
Strongylognathus	testaceus	Sozialparasit von T. caespitum
Myrmica	spp.	gegen Bodenverdichtung wenig empfindlich
Myrmica	sabuleti	ziemlich xerothermophil, meidet stark beschattete und feuchte Böden; Trocken- und Halbtrockenrasen, Heideland, Grasland
Myrmica	schencki	offene, ausreichend besonnte, xerotherme Stelle mit niedriger Bodenvegetation, meidet ruderale und eutrophierte Lebensräume (Überdüngung mit anschliessender Vergrasung wirkt sich bestandsmindernd aus)