

See discussions, stats, and author profiles for this publication at: <https://www.researchgate.net/publication/221769163>

Pine and mistletoes: How to live with a leak in the water flow and storage system?

Article in *Journal of Experimental Botany* · January 2012

DOI: 10.1093/jxb/err432 · Source: PubMed

CITATIONS

40

READS

93

4 authors, including:



Roman Zweifel

Swiss Federal Institute for Forest, Snow and Landscape Research WSL

57 PUBLICATIONS 2,451 CITATIONS

[SEE PROFILE](#)



Andreas Rigling

Swiss Federal Institute for Forest, Snow and Landscape Research WSL

155 PUBLICATIONS 7,301 CITATIONS

[SEE PROFILE](#)



Frank Sterck

Wageningen University & Research

144 PUBLICATIONS 4,263 CITATIONS

[SEE PROFILE](#)

Some of the authors of this publication are also working on these related projects:



Beyond leaf economics: Integrating root, leaf and stem traits to examine resource acquisition and tree growth [View project](#)



Tree Species Interactions under Soil Drought Conditions [View project](#)

RESEARCH PAPER

Pine and mistletoes: how to live with a leak in the water flow and storage system?

Roman Zweifel^{1,2,*}, Sara Bangerter^{3,2}, Andreas Rigling¹ and Frank J. Sterck⁴

¹ Swiss Federal Institute for Forest, Snow and Landscape Research (WSL), Forest Dynamics, Zürcherstrasse 111, CH-8903 Birmensdorf, Switzerland

² University of Bern, Institute of Plant Sciences, Switzerland

³ ETH Zurich, Institute of Agricultural Sciences Eschikon, Switzerland

⁴ Wageningen University, Centre for Ecosystem Studies, Wageningen, The Netherlands

* To whom correspondence should be addressed. E-mail: roman.zweifel@natkon.ch

Received 26 August 2011; Accepted 7 December 2011

Abstract

The mistletoe, *Viscum album*, living on Scots pine (*Pinus sylvestris*) has been reported barely to regulate its transpiration and thus heavily to affect the gas exchange of its host. The extent of this mistletoe effect and its underlying mechanism has, so far, only been partially analysed. In this study, pine branches with different mistletoe infestation levels were investigated by sap flow gauges and analysed with a modelling approach to identify the mistletoe-induced stomatal regulation of pine and its consequences for the water and carbon balances of the tree. It was found that *Viscum album* barely regulates its stomata and that pines consequently compensate for the additional water loss of mistletoes by closing their own stomata. Despite the reduced stomatal aperture of the needles, the total water loss of branches with mistletoes increased. Furthermore, the increasingly closed stomata reduced carbon assimilation for the pine. Such a negative effect of the mistletoes on pine's stomatal conductance and carbon gain was particularly strong during dry periods. Our study therefore suggests that mistletoe-induced stomatal closure is a successful mechanism against dying from hydraulic failure in the short term but increases the risk of carbon starvation in the long term. With the current conditions in Valais, Switzerland, a tree with more than about 10–20% of its total leaf area attributable to mistletoes is at the threshold of keeping a positive carbon balance. The currently increasing mistletoe abundance, due to increasing mean annual temperatures, is therefore accelerating the ongoing pine decline in many dry inner-Alpine valleys.

Key words: Carbon starvation, drought stress, *Pinus sylvestris*, stomatal regulation, tree water deficit, *Viscum album*, water storage.

Introduction

Mistletoes are known to be hemi-parasites that completely rely on the water and nutrient resources of their hosts, but, at least partially, assimilate their own carbon by photosynthesis (Schulze *et al.*, 1984; Glatzel and Geils, 2009). In addition, they may profit from carbon compounds in the sap of the host (Marshall *et al.*, 1994; Reblin *et al.*, 2006). As a consequence, infested trees respond with reduced growth (Tennakoon and Pate, 1996), defoliation (Meinzer *et al.*, 2004), a reduction in the overall photosynthetic tissue of the host (Rigling *et al.*, 2010) and, therefore, with a general loss of

capacity to assimilate carbon (Meinzer *et al.*, 2004). Infested trees are thus affected in several ways by the mistletoes: they lose water, nutrient, and carbon to the hemi-parasite (Galiano *et al.*, 2011), they need to reduce their total leaf area, have to adapt their wood structure, and thus they need to adjust their entire hydraulic system to the new conditions (Meinzer *et al.*, 2004). They also have to deal with an uncontrollable water sink in their water flow and storage system which may become a challenge in the daily optimization process when balancing losing water against taking up CO₂.

Some of the mistletoe species are reported to keep stomata open in an almost unregulated way. They thus maintain transpiration rates even under dry conditions (Schulze *et al.*, 1984; Marshall *et al.*, 1994; Reblin *et al.*, 2006; Escher *et al.*, 2008) and are assumed to cause lower crown water potentials in the host and, as a consequence, play a significant role in the host's tree water relations (Reblin *et al.*, 2006). These mistletoe species are therefore able to acquire nutrients and xylem-sap dissolved carbons via the host tree during both favourable wet conditions as well as under dry conditions (Schulze *et al.*, 1984). This short-term advantage seems to outweigh the long-term disadvantage of weakening and damaging the host on which the hemi-parasite is relying.

As long as crown water potentials remain sufficiently high and sufficient water is available for the host tree, the extra water loss by the mistletoes may not harm the host tree. Under drought conditions, however, infested host trees may lose a relatively large amount of water via mistletoes that persist transpiring, and they may no longer be able to control their water status. Such trees may be subjected to cavitations in the water flow system (Jackson *et al.*, 1995; Zweifel and Zeugin, 2008) and to reduced carbon assimilation due to drought-driven stomatal closure (Meinzer *et al.*, 2004; Zweifel *et al.*, 2009).

Mistletoes in a dry environment: Valais, Switzerland

Scots pine (*Pinus sylvestris* L.) is a potential Eurasian host species of the mistletoe *Viscum album* ssp. *austriacum* (Wiesb.) Vollmann (Zuber, 2004). This mistletoe species is reported barely to regulate the water loss by transpiration (Escher *et al.*, 2008). In central Valais, a dry inner-Alpine valley of Switzerland, pine trees grow extremely slowly and are probably at the edge of their physiological capability to survive (Rigling *et al.*, 2002; Zweifel *et al.*, 2009; Dobbertin *et al.*, 2010; Eilmann *et al.*, 2011). These pines are easily infested by the hemi-parasite *Viscum album* as has been observed for Scots pine in other dry inner-Alpine valleys of Austria and Italy (Vertui and Tagliaferro, 1996; Oberhuber, 2001). Pines infested by mistletoes have a two to four times higher mortality probability than non-infested trees (Dobbertin and Rigling, 2006; Rigling *et al.*, 2010). Moreover, after dry years, the increased mortality of trees locally led to a reduction in the abundance of Scots pine by up to 50% (Rebetez and Dobbertin, 2004). Several investigations in Valais showed an increasing pine mortality (Dobbertin *et al.*, 2005b, 2007; Bigler *et al.*, 2006; Eilmann *et al.*, 2009) paralleled by an increasing infestation rate of *Viscum album* over the last century (Dobbertin *et al.*, 2005a, b; Dobbertin and Rigling, 2006). Both processes are most likely driven by a rise in average annual temperature of about 2 °C over the past 100 years (Bigler *et al.*, 2006; Zweifel *et al.*, 2009).

Even though several indications of a direct effect of mistletoes on the survival probability of pine have been discussed, so far no mechanism has been shown that quantifies the effect of different mistletoe infestation levels on tree metabolism in terms of water relations and carbon balance. In this study, we

start from the idea that mistletoe infestation creates a leak in the water flow system of pines and thus causes stomatal closure and lower transpiration and assimilation rates. As a result, these slow-growing pines may not survive because they cannot maintain a positive carbon balance. To test these ideas, water relations were compared and these water relations were coupled to carbon gain for Scots pine branches with different mistletoe infestation levels (Fig. 1) at a southerly exposed site at Salgesch, Valais, Switzerland. The aim was to explain the effects of mistletoe transpiration on the crown water potential, the leaf area relative to sapwood area and the capacitance of the crown and, in turn, on the stomatal aperture, transpiration, and assimilation of pine. This approach was used to quantify the impact of different mistletoe infestation levels on the gas exchange and carbon gain of pine trees and the following hypotheses were tested: (i) pine compensates for mistletoe-induced water loss by reducing the stomatal conductance of their needles due to lower crown water potentials, particularly under dry conditions; (ii) the crown conductance, transpiration, and carbon gain is expected to decrease as a short-term response to the mistletoe infestation. In the long-term, infested pine trees may respond to the generally increased drought stress by reducing their leaf area; (iii) for the slow-growing trees of this dry valley, infested plants rapidly lose the capability of maintaining a positive carbon balance, in particular, under persistently dry conditions.

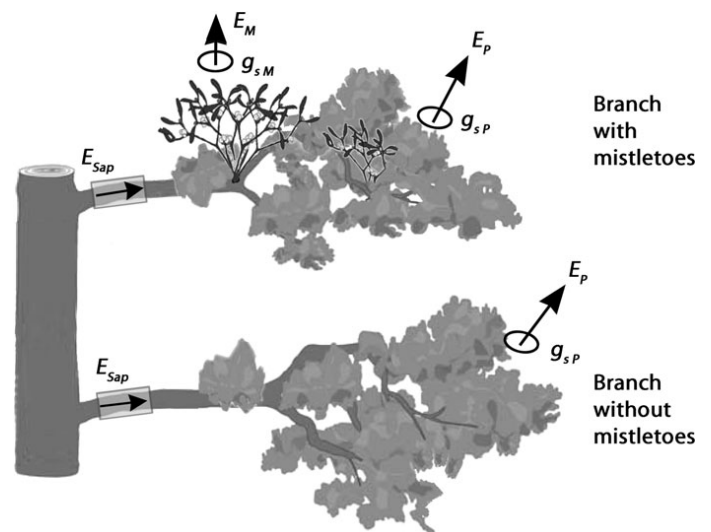

Fig. 1. Pine branches (*Pinus sylvestris*) with and without mistletoes (*Viscum album* ssp. *austriacum*) were investigated by sap flow gauges in order to analyse the impact of the mistletoe transpiration (E_M) on the host's gas exchange, particularly its stomatal conductance (g_{sP}). Non-infested branches are able to use the water withdrawn into the branch (E_{Sap}) entirely for their own transpiration (E_P) whereas infested branches share the water with the hemi-parasite. All branches investigated within the tree crowns were fully light-exposed. The height of the crown was not systematically ordered like it is shown in this drawing. In three cases, the measured branch with mistletoes was higher in the tree, in two cases it was lower.

Materials and methods

Study site and investigated trees

The study site was located in an open oak-pine woodland near Salgesch on the south-facing slope of the main valley of the Valais, Switzerland (46°19'27' N, 7°34'40' E, 985 m asl). Central Valais is an inner-Alpine valley characterized by a dry climate. Mean annual precipitation over the past 20 years has been about 600 mm per year (Zweifel *et al.*, 2009). Annual precipitation was 500 mm in the year of investigation (2004). For this site, annual rainfall showed large fluctuations but had not changed over the last century. The annual temperature, however, had increased by about 2 °C during the same period (Zweifel *et al.*, 2009).

Pubescent oak (*Quercus pubescens* Willd.) and Scots pine (*Pinus sylvestris* L.) were the most abundant tree species and juniper (*Juniperus communis* L.) was the most abundant woody shrub in the vegetation of this very dry site. The pines investigated occurred in the typical patches of trees (oak, pine, *Viburnum lantana*, and juniper) surrounded by grass and bare rock. The soil on this steep south-facing slope (~25°) was shallow with a depth of 0.1–0.3 m at the site of measurement. Below the organic material was a mostly solid rock layer.

For this study, five pine trees were selected within 30 m of the trees investigated in earlier studies on drought-stressed pines (Zweifel *et al.*, 2005, 2006, 2007, 2009; Sterck *et al.*, 2008; Zweifel and Zeugin, 2008). The selected trees represented mature individuals with estimated ages between 100–120 years. The height of the pines ranged between 3.5–5.0 m, the stem diameter between 11.9–23.2 cm, and the crown projection area on the ground between 8 m² and 18 m². For each tree, a branch without mistletoes and one or two branches with mistletoes was selected. Branches were therefore obtained with different levels of mistletoe infestation, ranging in relative leaf area of mistletoe (RLA_M) from 0% (the control branches) to 100% (only mistletoes, no needles left) (Table 1; Fig. 1).

Table 1. Characteristics of branches with sap flow gauges: cross-sectional area of the branch (CSA), needle leaf area (LA_P), mistletoe leaf area (LA_M), relative mistletoe leaf area (RLA_M) on total leaf area (TLA), and the total sap flow per branch over the period from 15 May to 1 September 2004 ($\sum E_{Sap}$).

Tree (letter)/ Branch (number)	CSA	LA_P [cm ²]	LA_M [m ²]	TLA [m ²]	RLA_M [m ²]	$\sum E_{Sap}$ [%]	Remarks [\square]
A1	3.08	0	0.082	0.082	100%	23.7	
B1	4.87	0.1	0.71	0.81	88%	85.7	
B2	2.28	0.38	<0.001	0.38	0%	7.9	
C1	7.53	1.59	0.34	1.93	18%	281.7	Mistletoes removed, 2 Sep 2004 (doy 246)
C2	9.23	2.75	0.0069	2.757	0%	118.2	
C3	2.40	0.72	0.039	0.759	5%	46.7	
D1	6.30	0.15	0.095	0.245	39%	51.2	
D2	7.65	1.69	<0.001	1.69	0%	102.5	
D3	3.25	0.35	0.1	0.45	22%	37.9	Mistletoes removed, 2 Sep 2004 (doy 246)
E2	6.26	1.13	<0.001	1.13	0%	28.1	

Measurement protocol

For the five pines, the microclimatic conditions were determined at a 10 min resolution between May and November 2004. Temperature, relative humidity, and photosynthetic radiation were used and resolved into southerly and northerly exposed crown parts. The microclimate outside of the forest (net radiation, wind speed, precipitation) at 2 m above ground level and soil water potentials at depths between 5 cm and 30 cm (Zweifel *et al.*, 2007) were also measured. Provided that the trees were relatively isolated and fully exposed on the same mountain slope and altitudinal range (975–985 m), it was assumed that the measured microclimate was the same for our trees (the maximum distance to microclimate measurements was 30 m).

For each selected branch, the sap flow (E_{Sap}) was measured by heat balance gauges (Dynagage, Dynamax, USA) at a 10 min resolution, from 15 May to 21 November 2004. On 22 November, the investigated branches and the mistletoes on those branches were harvested. For each branch, pine needle area (LA_P) and mistletoe leaf area (LA_M) were measured using SCAN and WinDIAS (Delta-T Devices Ltd., UK). From this information, the total leaf area (TLA) was calculated as the sum of LA_P and LA_M , and the mistletoe infestation level RLA_M as the ratio of $LA_M:TLA$ (Table 1). The branch cross-sectional area (CSA) at the branch base was also measured. For two of the infested branches (C1 and D3, Table 1), a different procedure was followed. For these branches, the mistletoes were collected on 2 September 2004 [day of year (doy) 246] to compare sap flow during and after mistletoe infestation. Pine needles were also collected from those branches in order to provide TLA and RLA_M as for all other selected branches.

Similar pines next to the sap flow trees were selected to measure the dynamics of leaf water potentials of needles and mistletoes (Ψ_{leaf}) with a pressure chamber (SKPM 1400, SKYE Instruments, UK) on ten days within the growing season of 2004, in which both wet and dry days were included. These additional trees were chosen to avoid destructive sampling on the 'sap flow trees'. For each measurement day, Ψ_{leaf} was recorded from pre-dawn until the evening, leading to about 10–15 records per day where each record represents the averaged value of 2–5 individually measured needles and mistletoe leaves, respectively. Needles and mistletoe leaves were taken from various branches with relative low infestation levels.

Model HPMZ07

The hydraulic plant model HPMZ07 by Zweifel *et al.* (2007) was used to simulate the physiological responses of pine branches with different mistletoe infestation levels (Fig. 2a). The model was run on a modelling platform called PhytoSim (PhytoSim, PhytoIT, Ghent, Belgium) using as input the microclimate data at a 10 min resolution, including radiation (Rad), vapour pressure deficit (VPD), wind speed (u_z), air temperature (T), and soil water potential (Ψ_{Soil}) (Fig. 2). The model was parameterized for each selected branch with trait values, including leaf area, sun exposure, and water flow distance from soil to branch periphery. In a first step, branch-specific potential evapotranspiration rates (ET_{Pot}) were calculated according to Zweifel *et al.* (2002). In the next step, the HPMZ07 was optimized for the branches investigated with sap flow gauges. The parameterization procedure minimized the deviation between (i) modelled total branch transpiration (TE) and measured branch sap flow (E_{Sap}), and (ii) the modelled branch water potentials (Ψ_{Crown}) and the measured leaf water potentials (Ψ_{leaf}). In addition, the model was restricted to fit an average course of dynamic stem radius changes for the respective period of analysis (the same course for all trees, data not shown; see Zweifel *et al.*, 2007). The branch-specific variables and modelling outputs included the water potentials from roots to branch, dynamic stomatal aperture of pine needles on the branch (θ_p), and water flow and storage processes within branches.

Based on the parameters of simulations obtained on individual branches, it was possible to parameterize a virtual branch with a total leaf area of 0.8 m² and with different mistletoe infestation

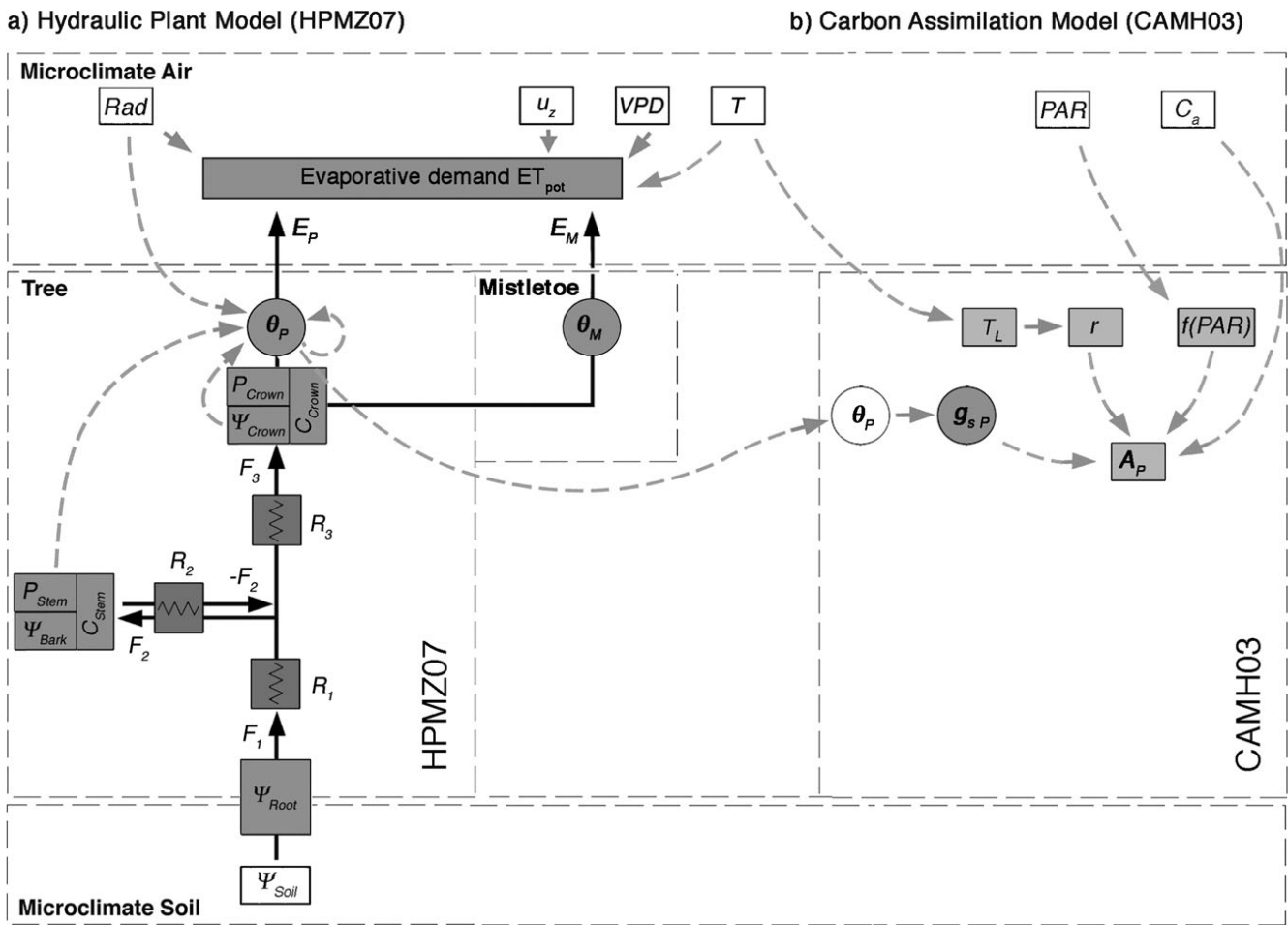

Fig. 2. Models applied to analyse the measured data. (a) Hydraulic plant model (HPMZ07) including stomatal regulation by Zweifel *et al.* (2007) and (b) adapted carbon assimilation model for pine trees (CAMH03) by Hari and Makela (2003) and Makela *et al.* (2004). Rad , net radiation; u_z , wind speed; VPD , vapour pressure deficit of the air; T , air temperature on the crown periphery; PAR , photosynthetic active radiation; C_a , ambient CO_2 concentration; ET_{pot} , potential evapotranspiration of the branch (needles and mistletoes); E_P , needle transpiration; E_M , mistletoe transpiration; θ_P , stomatal aperture pine; θ_M , stomatal aperture mistletoes; T_L , leaf temperature; r , leaf respiration; $f(PAR)$, light saturation curve; P_{Crown} , crown water content; Ψ_{Crown} , crown water potential; C_{Crown} , crown water capacitance; g_{sP} , stomatal conductance of pine; A_P , net carbon assimilation of the pine; F_x , water flow rates; R_x , water flow resistances; P_{Stem} , stem water content; Ψ_{Bark} , bark water potential; C_{Stem} , stem water capacitance; Ψ_{Root} , root water potential; Ψ_{Soil} , soil water potential. Input variables are in frames with a white background, whereas model calculated variables are in frames with a grey background. The two models are linked by θ_P which is calculated by the HPMZ07 and used as input in the CAMH03.

levels RLA_M : 0%, 5%, 10%, 20%, and 40%. These virtual branches were used to analyse the effects of mistletoe infestation on the dynamics in tree water relations, stomatal closure, and carbon gain. The mistletoe stomata were kept constantly open according to Escher *et al.* (2008) and based on own measurements. Thus, water evaporating from the mistletoe surface was modelled as a (very big) cuticular transpiration, with a constant stomatal aperture of the mistletoes (θ_M). θ_M together with the stomatal aperture of the pine needles θ_P equals the total branch stomatal aperture $T\theta$ ($T\theta \leq 1$). Thus the five mistletoe infestation levels (RLA_M) could be described with increasing values for θ_M . Based on the optimized parameters for individual branches, the branch water storage capacitance C_{Crown} was decreased with increasing infestation level. All other parameters were found to be constant or independent of RLA_M . A detailed description of the HPMZ07 and its parameters can be found in Zweifel *et al.* (2007).

Model CAMH03

The gas exchange model CAMH03 is based on the idea of optimal stomatal control (Cowan and Farquhar, 1977) and was adapted

and optimized for pine trees (Hari and Makela, 2003; Makela *et al.*, 2004). CAMH03 was used to quantify the stomatal regulation-dependent net carbon assimilation (A_P) of the pine branches investigated (without the assimilation of the mistletoes). The model needs air temperature (T), photosynthetic radiation (PAR), and CO_2 concentration of the air (C_a) as input (Fig. 2b). In addition, the stomatal aperture values (θ_P), derived from the HPMZ07 model, were transformed into stomatal conductances (g_s) to substitute the optimal stomatal control approach (Cowan, 1977) in the CAMH03. The relationship between θ_P and g_s has been shown to be very close (Lawson *et al.*, 1998) and a transformation from θ_P into g_s can be done with a Hagen–Poiseuille approach:

$$g_s = \frac{\Delta P}{\Delta L} \times \frac{(\theta_P \times R_{St} \times P_i \times sF \times i)^2}{8\eta} + g_{s,min} \quad (1)$$

where $\Delta P/\Delta L$ is the pressure gradient through the stomata, R_{St} is the average stomatal radius, sF is the stomatal frequency on a needle, i is an empirical weighting factor, $g_{s,min}$ is the minimum stomatal conductance, and η is the viscosity of air. The model calculates leaf respiration (r) and net carbon assimilation of the

pine branch (A_p). Further details about parameterization and model equations of the CAMH03 can be found in Hari and Makela (2003) and Makela *et al.* (2004). Abbreviations used in the models and for measurements are listed in Appendix A.

Results

Measured branch sap flow rates and water potentials

Measured branch sap flow rates (E_{Sap}) and thus, total modelled branch transpiration (pine needles+mistletoes, TE) markedly increased with increasing mistletoe infestation levels (RLA_M) (Fig. 3a). And this increase in E_{Sap} was found despite a decreasing total leaf area (TLA) per branch cross-sectional area (CSA) with increasing RLA_M (Fig. 3b). Mistletoes were therefore calculated to have about a six times higher transpiration rate per leaf area compared with pine needles (averaged over a 17 d period, 24 May to 10 June 2004; Fig. 3a) and their leaf water potentials Ψ_{LeafM} dropped to significantly lower values (-3 MPa) than the ones in the pine needles (Ψ_{LeafP} : -2 MPa) (Fig. 3c). Therefore, a pine branch with 5% mistletoes lost, on average, 25% of its transpired water through the hemi-parasite, and a branch

with 10% mistletoes lost 45% (Fig. 3d). This large fraction of water loss through the mistletoes was caused by the very passive, or non-existent regulation of mistletoe stomata (Fig. 4). As an example, the total sap flow of the mistletoe-branch B1 (branch consisting of mostly mistletoes, $RLA_M=88\%$) very closely followed the potential transpiration (which means no stomatal down-regulation of the transpiration) whereas the sap flow of the branch without mistletoes B2 ($RLA_M=0\%$) showed a distinct deviation from the potential transpiration clearly indicating stomatal closure (Fig. 4a). Under very dry conditions, the mistletoe-branch also began to show some deviation from the potential transpiration (Fig. 4b), however, it was very moderate compared with branches without mistletoes. In summary, mistletoes hardly regulated their stomata and were thus over-proportionally monopolizing and transpiring the water supplied by the branch and they increased the total branch transpiration.

Model quality

The model HPMZ07 was able appropriately to catch the different sap flow courses of all branches independently of

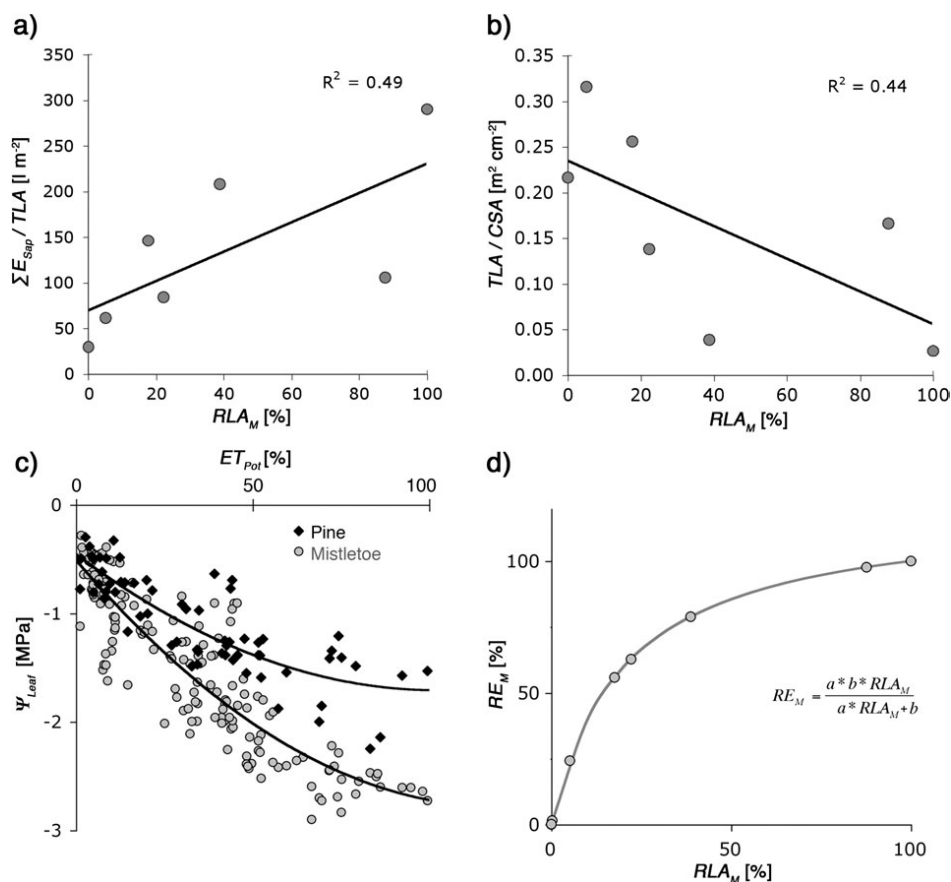

Fig. 3. Measured characteristics of pine tree branches with different mistletoe infestation levels. (a) Relationships between increasing relative mistletoe leaf area (RLA_M) and branch sap flow ($\sum E_{\text{Sap}}$) per total leaf area (TLA) over a measurement period of 17 d (24 May to 10 June 2004). (b) Relationships between RLA_M and the ratio between TLA and the branch cross-sectional area (CSA). (c) Leaf water potentials (Ψ_{Leaf}) of pine needles and mistletoes in relation to the evaporative demand of the air quantified as potential evapotranspiration (ET_{Pot}). (d) Increasing RLA_M led to an over-proportional increasing mistletoe transpiration relative to the total branch transpiration (RE_M). The asymptotic curve can be described with the equation given, where $a=5.9$ is the empirically derived ratio between maximum transpiration of mistletoes and pine needles (per m^2 leaf area) and $b=1.2$ is the asymptote.

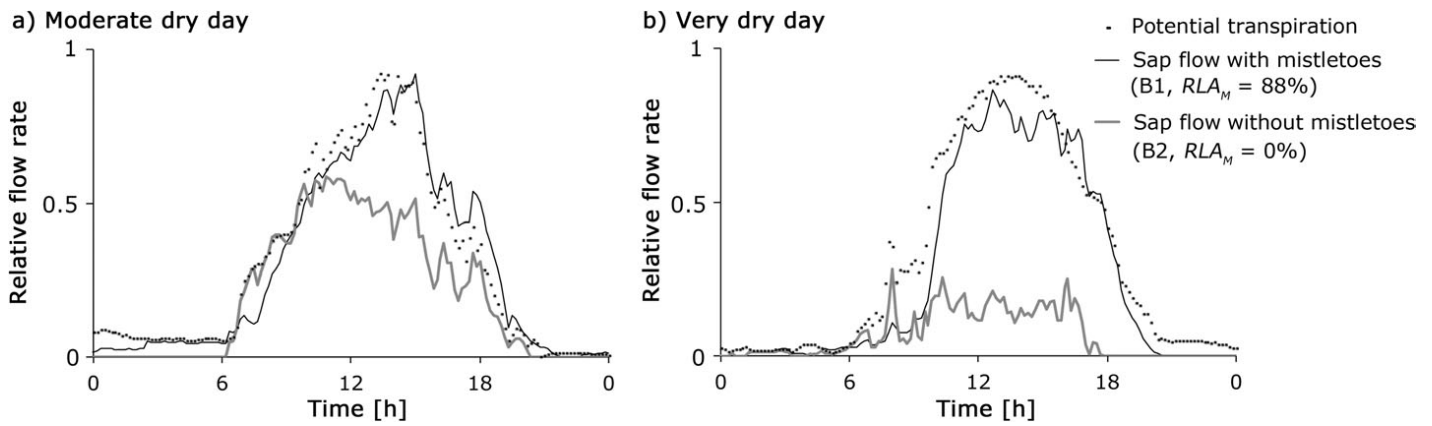
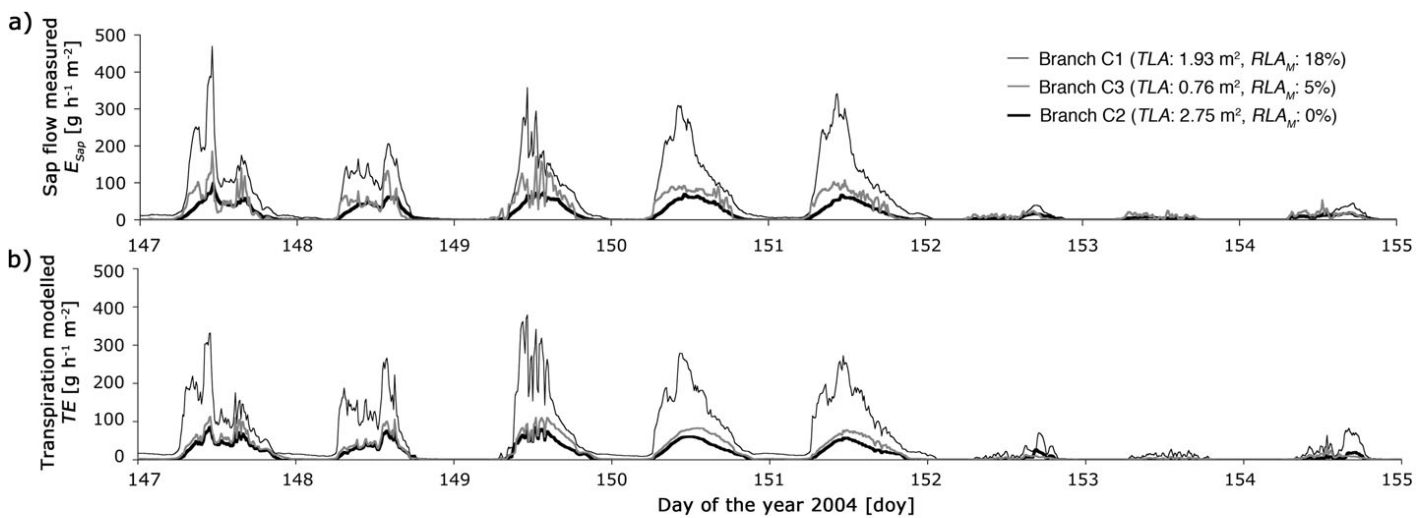

Fig. 4. Indication for non-regulated mistletoe stomata. (a) The measured sap flow of a branch (B1) with a very high mistletoe fraction ($RLA_M=88\%$) followed very closely the potential transpiration (22 August 2004, soil water potential = -120 kPa), whereas the sap flow of a branch without mistletoes (B2, $RLA_M=0\%$) showed a strong deviation of it. (b) Under very dry conditions (7 August 2004, soil water potential = -300 kPa), the difference in sap flow between the two branches even increased, however, B1 also showed a slight deviation from the potential transpiration on that day.



C) Measurement vs. Model

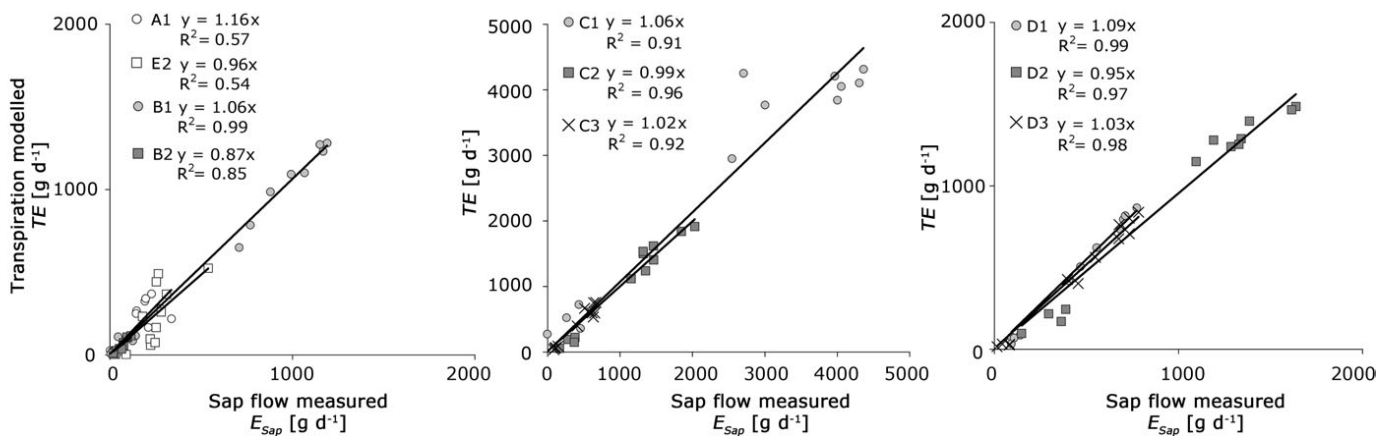

Fig. 5. Model quality. (a) Measured branch sap flow rates (E_{Sap}), normalized for the respective branch leaf area, were compared to (b) modelled branch transpiration (TE) at a 10 min resolution. (c) Linear regressions were calculated for the absolute daily sums of E_{Sap} and TE of the branches investigated (Table 1).

the respective mistletoe infestation level RLA_M . The simulated branch transpirations fitted the measured branch sap flow rates in a 10 min resolution and in a daily resolution very well (Fig. 5). Again, the highest sap flow rates per total branch leaf area (including mistletoes and needles) were measured for branches with the highest fractions of mistletoes, indicating barely regulated mistletoe stomata. The largest deviations between measured sap flow rates (E_{Sap}) and modelled transpiration rates (TE) occurred for the branches A1 and E2 (Fig. 5c). The two trees showed very sharp break-ins of the branch sap flow rates on the driest days (data not shown), which was not appropriately caught by the model. Such sap flow courses are known from trees or branches with runaway cavitations (Zweifel and Zeugin, 2008) indicating more severe drought stress of these two trees compared with the others involved in this study.

Impact on stomatal regulation

Modelling pine branches with increasing mistletoe infestation levels revealed a strong stomatal down regulation of the transpiration of pine needles (Fig. 6) when keeping the unregulated stomata of mistletoe open (Figs 4, 5). The average stomatal aperture of a branch (θ_P) strongly decreased with increasing water loss through the mistletoes. As a rule of thumb: the average reduction of stomatal aperture (in %) was similar to the percentage of mistletoes of a branch (RLA_M). These averaged values, however, masked the very wide variety of pine responses to different levels of drought stress (Fig. 7). Wet days after a rain event induced no or only very little additional stomatal closure in needles of branches with mistletoes (e.g. doy 154–156, Fig. 7b). With increasing drought, however, the impact of the mistletoes on pine stomata strongly increased (e.g. doy 145–151, Fig. 7b). The drier it became and the bigger the evaporative demand the more water was lost through the mistletoes and the more the stomata of the pine closed. However, the closed pine stomata on the driest days (e.g. doy 150–151, Fig. 7b), particularly those on branches with high mistletoe infestation levels, could not completely compensate for the unregulated transpiration through the mistletoes (Fig. 7c). This led to increasing total branch transpiration rates (TE) of mistletoe branches despite the closed stomata of the pine needles (Figs 3, 6, 7c). In particular, branches with a high infestation level had a significantly higher total transpiration on dry days than branches without mistletoes (e.g. doy 150–151, Fig. 7c).

Along drought gradients of VPD and soil water potential (Ψ_{Soil}), there appeared a systematic decrease of the average stomatal aperture in pine needles with increasing mistletoe infestation levels (RLA_M) (Fig. 8). The average stomatal response was not linear either to VPD or to Ψ_{Soil} , however an increasing RLA_M led always to increased stomatal drought responses in the form of decreasing θ_P .

Impact on net carbon assimilation

Modelled net carbon assimilation (A_P) of pine branches was increasingly reduced with increasing mistletoe fraction (RLA_M)

(Fig. 7d), mainly explicable by a decreased stomatal aperture θ_P (Figs 6, 7b). The reduction of A_P in relation to RLA_M was even more pronounced than the one of θ_P (Fig. 6). The two investigated driving factors VPD and Ψ_{Soil} induced distinct reductions in θ_P and A_P with increasing drought and more mistletoes (Fig. 8). It was the combination of the climatic stress and the biological stress that had the biggest effects. The drier it was, and the more mistletoes a branch carried, the more closed were the stomata (Fig. 7b) and, consequently, the more reduced was net carbon assimilation (Fig. 7d).

Mistletoe removal experiment

The mistletoes from two branches C1 and D3 (Table 1) were removed to show the direct impact of the hemi-parasite on the sap flow dynamics and the stomatal aperture courses of a pine branch (Fig. 9). The removal reduced the measured sap flow rate (E_{Sap}), and thus the total branch transpiration (TE) (Fig. 9a) and rapidly re-opened the stomata of the pine needles due to the sudden release of under-pressure in the mistletoe-cleared branches (Fig. 9b). A comparison between the transpiration rates for a branch once modelled with mistletoes and once without revealed that not only the absolute amount of transpired water changed but also the branch's response to the microclimatic conditions (Fig. 9c). The branch with mistletoes followed more closely the evaporative demand of the air and showed more transpiration in the second half of the day according to the findings in Fig. 4a. By contrast, the same branch without mistletoes was more decoupled from the evaporative demand since there was no water escaping through the uncontrollably opened stomata of the mistletoes (Fig. 9c). The pine branch without mistletoes was therefore able fully to control its water loss via its stomatal regulation. This effect was most distinct on dry days as shown before (Figs 3, 4, 7, 8).

Discussion

Gas exchange of pine trees was heavily affected by the presence of mistletoes of the species *Viscum album*. As already reported by Escher *et al.*, (2008), this mistletoe species was found not to regulate its water loss at all (Fig. 4a) or in a very passive way under the most extreme drought conditions measured (Fig. 4b). The slight deviation of measured transpiration from potential transpiration under very dry conditions may be interpreted as stomatal closure of the mistletoes or, more likely, as a failure of the water-conducting system to provide the necessary water for the water demand of the air despite the fully open mistletoe stomata. Such a potential xylem dysfunction induced by cavitation (Cochard, 1992; Poyatos *et al.*, 2008) could have occurred in the roots, in the stem, in the branches or even in the mistletoe itself and seemed to be reversible since the phenomenon disappeared under moister conditions. As a direct consequence of this mistletoe-induced leak in the water flow and storage system, it was found that the infested pine trees compensated for the uncontrollable loss of water by reducing

their own transpiration at the cost of a decreasing carbon gain with higher mistletoe infestation levels (Figs 6, 7).

Mistletoe-induced stomatal closure in pine needles

In line with our hypotheses, mistletoe-infested trees decreased their stomatal aperture as a short-term response to drought stress, *inter alia* induced by the additional transpiration of

the hemi-parasite (Figs 6, 7, 8). In the long term, the infestation led to a reduction in the (needle) leaf area (Fig. 3b) as already reported before (Rigling *et al.*, 2010). Both types of responses contributed to stabilize the tree's water balance but resulted in a significant decrease in carbon gain of the infested pine trees. Hence, stomatal closure is a short-term response against dying of thirst but increases the risk of carbon starvation in the long run.

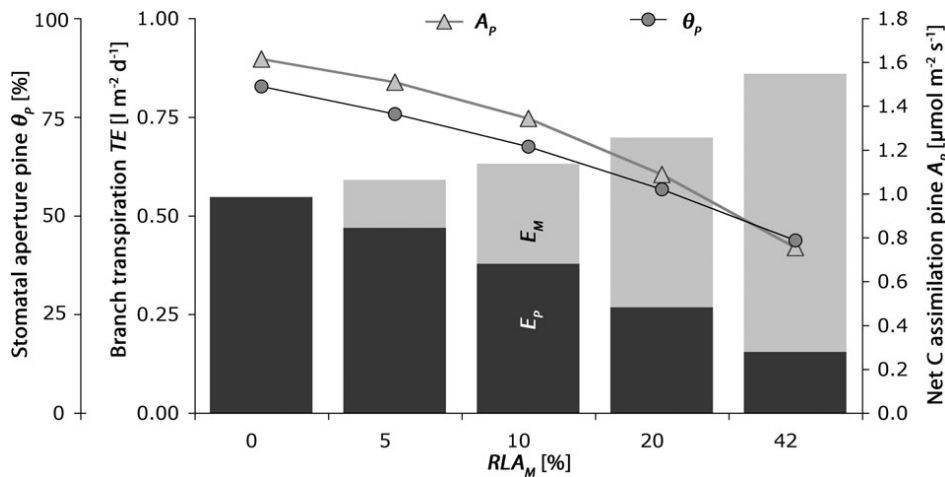

Fig. 6. Modelled mean transpiration of pine needles (E_p) and mistletoes (E_M) with increasing fractions of mistletoe leaf area on total leaf area (RLA_M). Correspondingly, the mean stomatal aperture of pine (θ_p) and the net carbon assimilation of pine (A_p).

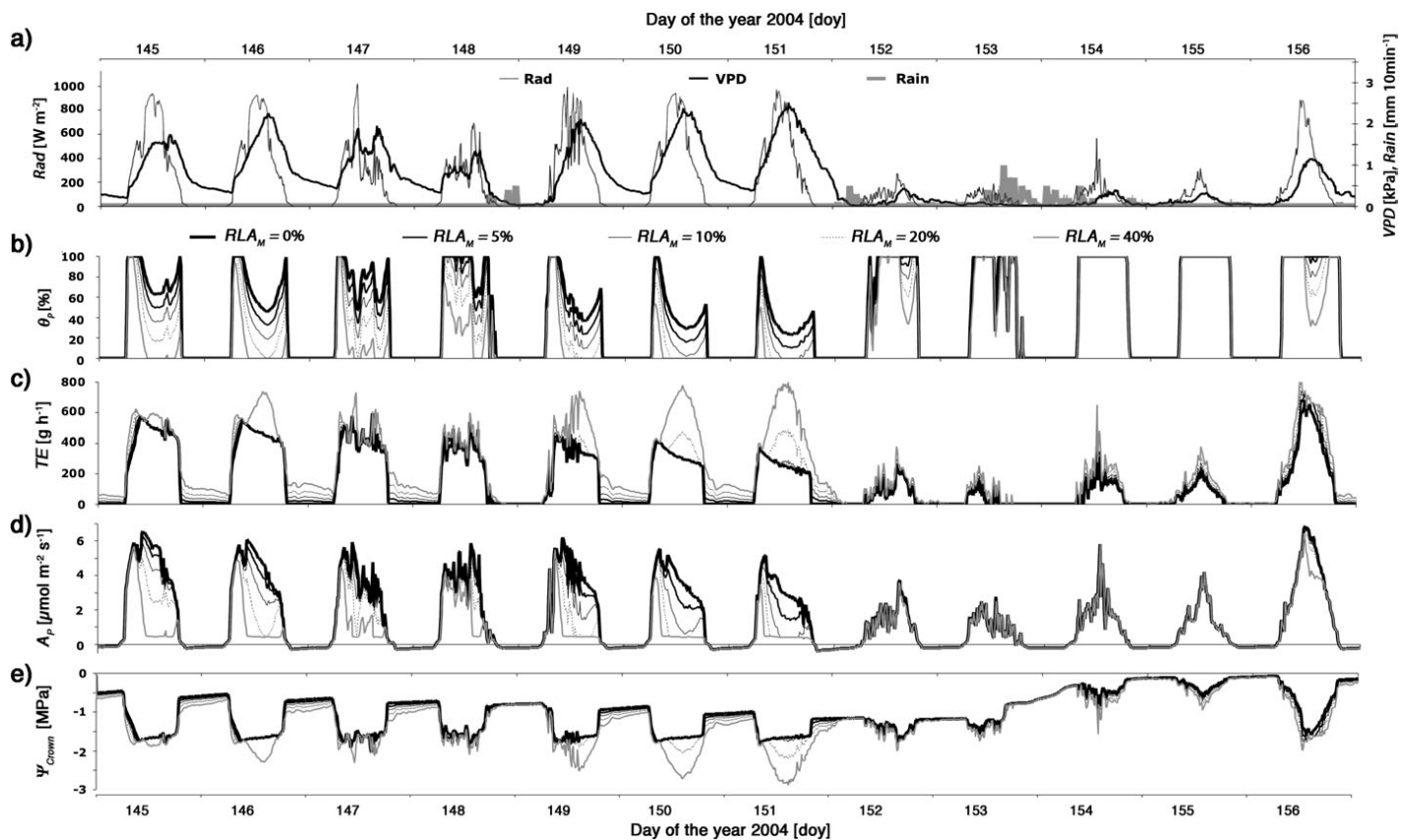

Fig. 7. Simulation of physiological variables of pine branches with increasing mistletoe infestation levels (RLA_M). (a) Microclimatic measurements of net radiation (Rad), vapour pressure deficit (VPD), and rain. (b) Stomatal aperture of pine needles (θ_p). (c) Total branch transpiration (TE). (d) Net carbon assimilation of pine needles (A_p) and (e) branch water potentials (Ψ_{Crown}) including pine needles and mistletoe leaves.

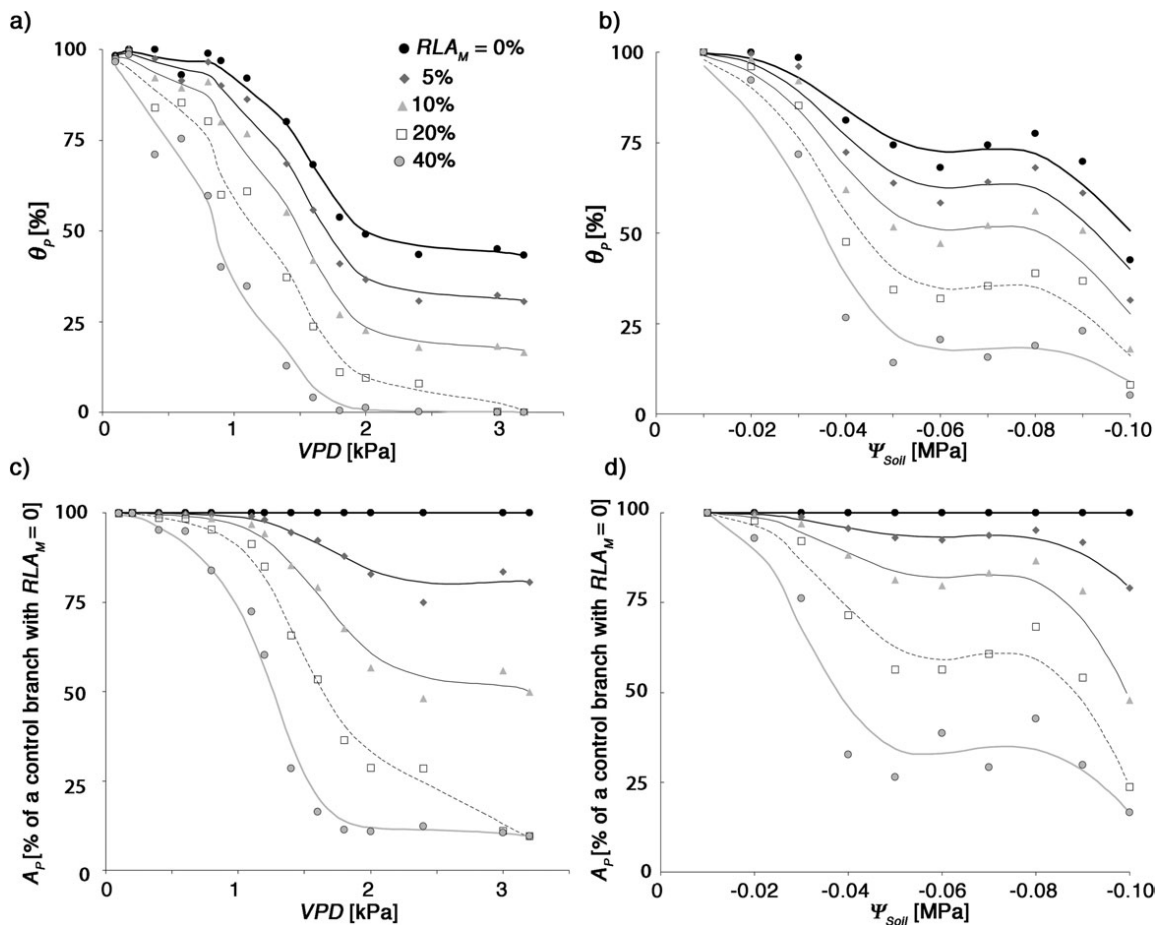

Fig. 8. Impact of increasing mistletoe infestation levels (RLA_M) on stomatal aperture (θ_P) (a, b) and net carbon assimilation (A_P) of pine needles (c, d) in relation to vapour pressure deficit (VPD) (a, c) and soil water potential (Ψ_{Soil}) (b, d). Branches without mistletoes were used as a control for maximum net assimilation in (c) and (d). Environmental variables are measured, stomatal aperture and net assimilation values are modelled. Displayed data contain day light hours only (07.00 h to 18.50 h).

It is most important to understand the direct impact of mistletoes on the pine's stomatal responses in our model analysis which was the lowered crown water potential (Fig. 7e), a consequence of the uncontrolled mistletoe transpiration. The investigation provides no measured data about the development of needle water potentials with increasing mistletoe infestation levels on a branch but shows that mistletoe water potentials are generally lower than the ones of the needles (Fig. 3c). It is assumed that this also affects the needle water potentials of an infested branch as indicated by the model results (Fig. 7e) and the mistletoe removal experiment (data not shown). Lowered leaf water potentials and, accordingly, decreasing turgor pressures, are known to have a strong closing effect on stomata (Buckley *et al.*, 2003; Ewers *et al.*, 2007; Zweifel *et al.*, 2007; Ache *et al.*, 2010) and is one of the main drivers for stomatal closure in the applied model HPMZ07 (Fig. 2) (Zweifel *et al.*, 2007). The very high model efficiency in terms of fitting the measured branch sap flow rates of different mistletoe infestation levels (Fig. 5) strongly indicates that the chosen modelling approach, and its dependency on lowered crown water potentials, is based on reasonable (model) assumptions and captures the underlying mechanism.

Branch water storage capacitance (C_{Crown}), estimated by the model HPMZ07, has been found to decrease logarithmically with the mistletoe infestation level RLA_M (result not shown). This decrease reflects a shift of the branch trait C_{Crown} with respect to the mistletoe infestation level. Overall, the decline in C_{Crown} indicates that the water storage and supply capacity of the branch decreased with increasing mistletoe fractions. There might be several reasons for this. Firstly, mistletoes may be less elastic in terms of water storage/supply than pine needles, that is they release less water per unit change in leaf water potential than the needles. Secondly, needles may acclimate to the lower water potentials on heavily infested branches and, in turn, end up with a lower capacitance and lower water supply from water reserves in the crown. From this it was hypothesized that apart from the obvious influence of mistletoe infestation on the crown water potential, a lower capacitance also contributes to stomatal closure of infested trees. There are no indications for other factors influencing stomatal closure, since the other parameters, for example, the total flow resistance (R_x) or the stomatal responsiveness to water potential, were found to be unchanged with increasing mistletoe infestation levels.

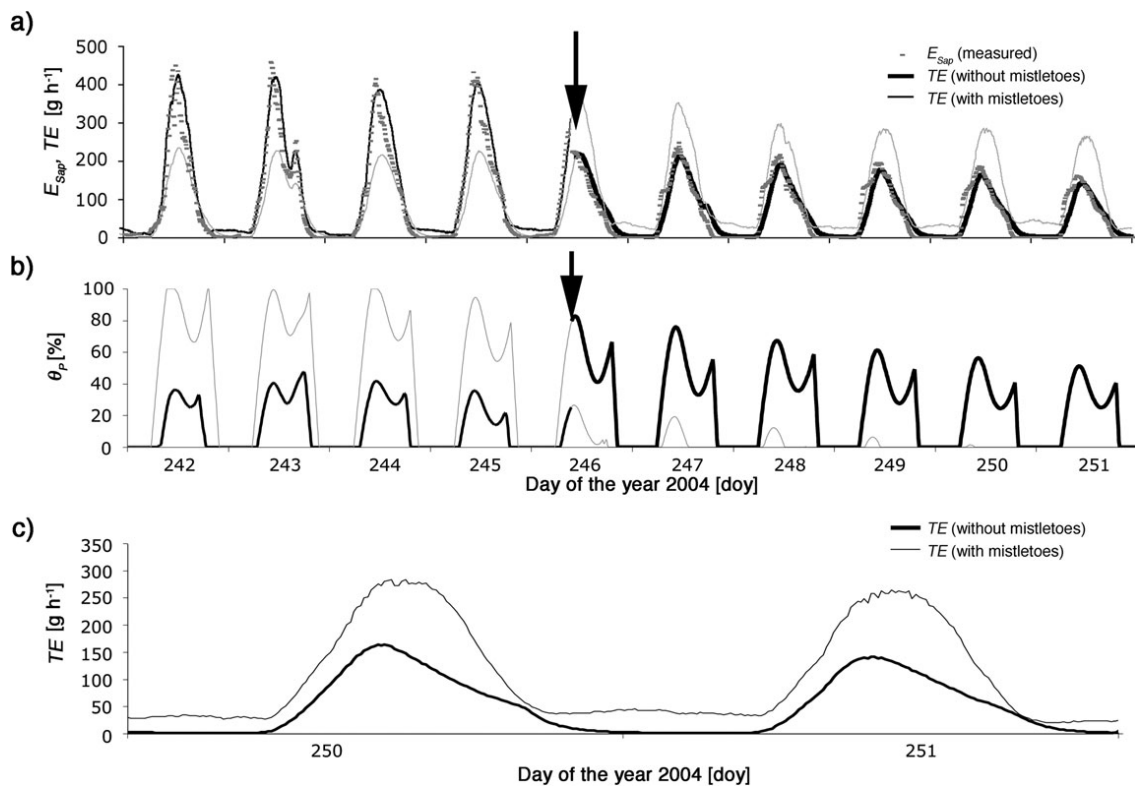

Fig. 9. Mistletoe removal experiment with branch C1. The time of removal is indicated by a black arrow. (a) Measured (E_{Sap}) and modelled (TE) day course of sap flow and branch transpiration of the four days before the mistletoe removal and the five days after it. Light grey lines show the predicted courses without mistletoes until doy 246, and with mistletoes after doy 246 (a, b). (b) Simulated stomatal aperture of pine needles (θ_p) of branch C1 (black line). (c) Courses of TE of branch C1 with (left axis) and without mistletoes (right axis) for the two driest days in this data series.

Despite the strong stomatal closure of pine needles observed on branches with mistletoes, the pine branches were not able to compensate fully for the uncontrolled loss of water through the mistletoes. This is in contrast to our hypothesis and became evident with the increasing sap rates per branch leaf area found with an increasing mistletoe infestation levels RLA_M (Figs 3, 6). It documents the fatal situation an infested pine tree in this dry environment lives in.

Combination of stress factors

It was hypothesized that pines face a decreased carbon gain with increasing levels of mistletoe infestation, particularly under dry conditions. It was indeed observed that the impact of mistletoe infestation levels on pine trees strongly depends on the degree of drought stress. Pine trees in a moist environment maintain more positive carbon budgets with more mistletoes than trees under drought stress. Pine trees in a dry environment, such as the ones investigated here, respond strongly to different levels of mistletoe infestation and drought stress (Figs 7, 8). Our results clearly revealed that increasing drought stress enlarges the effect of mistletoes on the tree water relations and carbon balance. An average increase of the daytime VPD by about 0.3 kPa changes the effect on the stomata of a branch with a $RLA_M=10\%$ into one of a $RLA_M=20\%$. The same happens

when the average soil water potential decreases by about 5 kPa (Fig. 8). These examples highlight the relative weight of mistletoes that are dependent on the microclimatic conditions. A mistletoe infestation level might be handled by a pine at the current climatic conditions but might be lethal in the (near) future when drought stress is increasing by increasing temperature and/or decreasing precipitation (Rebetez and Dobbertin, 2004; Ciais *et al.*, 2005).

Impact on pine's carbon balance

It was hypothesized that, for the slow-growing trees of this dry valley, the infested plants would rapidly lose the capability of maintaining a positive carbon balance, in particular, under persistently dry conditions. The literature already suggests that mistletoes affect the tree's carbon balance in many ways: they consume dissolved carbons from the host's sap (Marshall *et al.*, 1994; Reblin *et al.*, 2006), and they reduce the total amount of photosynthetic tissue and the capacity for carbon gain of the host in the long term (Rigling *et al.*, 2010). In our analysis, it is shown that the most important factor is that mistletoes induce stomatal closure in pine, particularly in dry conditions, and thus limit the uptake of CO_2 (Figs 6, 7). Assuming that our branch simulation can be scaled to the whole tree, our results suggest that a pine tree without mistletoes reaches, on average, a net carbon assimilation A_p of $1.6 \mu\text{mol m}^{-2} \text{s}^{-1}$

(Fig. 6). This magnitude of A_P is reasonable and fits well into the range of other findings (Larcher, 2003; Makela *et al.*, 2004). Also the needle respiration ($r=1 \mu\text{mol m}^{-2} \text{s}^{-1}$), an intrinsic fraction of A_P in the CAMH03, is very close to the needle respiration of pine found by Zha *et al.* (2004) ($r=1.1 \mu\text{mol m}^{-2} \text{s}^{-1}$). Our simulations suggest that A_P is reduced with increasing mistletoe infestation levels (RLA_M), and reaches values around $0.7 \mu\text{mol m}^{-2} \text{s}^{-1}$ for a RLA_M of 40% (Fig. 5). Comparing A_P altered by increasing RLA_M to the reported maintenance respiration of pine trees (Larcher, 2003: $0.5\text{--}0.7 \mu\text{mol m}^{-2} \text{s}^{-1}$, Janssens *et al.*, 2002: $1\text{--}1.3 \mu\text{mol m}^{-2} \text{s}^{-1}$, without needle respiration), it is concluded that a mistletoe infestation level RLA_M between 10% and 20% may already be crucial for pine trees at our dry site (Fig. 5). Such a RLA_M reduces A_P to about the threshold for the estimated carbon need for maintaining the tree's functionality, growth not yet included. Even if it is assumed that the tree respiration does not remain constant but is reduced with increasing mistletoe infestation levels, the findings do not completely change. Very small annual tree rings of pine trees measured between 0.5 mm and 2.5 mm in this area (Zweifel *et al.*, 2006; Eilmann *et al.*, 2011) further support this finding of a carbon-limited pine tree due to a lack of water (Eilmann *et al.*, 2010). Whether a potential tree death at the end is a direct effect of carbon starvation (Adams *et al.*, 2009) or is induced by fatal damage in the water transport system by cavitation (Sperry, 2003; Leuzinger *et al.*, 2009; Sala, 2009) is not answered here.

How to live with a leak in the water flow system?

Pine trees have a subtly regulated water system but no effective mechanism to fight mistletoe infestation or to control the hemi-parasite's unregulated release of water by transpiration. From a systems analytical point of view, pine trees with mistletoes have a leak in their water flow and storage system and the only way to live (survive) with the situation is to compensate for the additional water loss through mistletoes by reducing its own transpiration by

closing the needle stomata. This work shows how the feedback from lowered branch water potentials and, probably, lower crown capacitance induce the closure of stomata in the pine needles. Moreover, it is shown that such responses become much stronger under dry conditions. Pines probably avoid cavitation by closing their stomata, but cannot avoid a lack of carbon gain under persistent dry conditions. Our results support the idea that the increasing abundance of mistletoes in Valais and other inner-Alpine valleys (Schulze *et al.*, 1984; Dobbertin *et al.*, 2005a; Dobbertin and Rigling, 2006; Glatzel and Geils, 2009; Rigling *et al.*, 2010) contributes to the loss of pine in these areas. In general, mistletoes do not directly lead to tree death but its presence in a tree magnifies the impact of drought and strongly reduces the capability of pine trees to assimilate carbon under dry conditions (Fig. 7). Our study therefore suggests that tree species' distribution patterns may change rapidly, mainly at the species' range limits, when ongoing climate change involves worse conditions accompanied by organisms that additionally stress the carbon balance as shown here for pine and mistletoe.

Acknowledgements

We are grateful to DM Newbery of the Institute of Plant Sciences of the University of Bern for supporting the field work in the Valais. We thank E Bhend for the great support with the set-up and maintenance of the research stations. We are indebted to Fabienne Zeugin, Lukas Zimmermann, Marijn Swart, Simone de Brock, and Alfred Chitiki for their fieldwork and helpful discussions. The research was part of the project 'Tree Response to Climate Change TRCC', supported by a Swiss Federal Research Fellowship for Roman Zweifel and is additionally funded by the Swiss National Science Foundation, project 'Thermoak' in NCCR 'Climate', the Institute of Plant Sciences of the University of Bern, and the Swiss Federal Research Institute WSL, Birmensdorf. Frank Sterck was financially supported by the SBP foundation of KNAW.

Appendix Abbreviations

Abbreviation	Description	Unit	Occurrence	Remark
E_{Sap}	Sap flow branch	g h^{-1}	Measurement	
TLA	Total branch leaf area	m^2	Measurement	$TLA=LA_M+LA_P$
LA_M	Leaf area mistletoes	m^2	Measurement	
LA_P	Leaf area needles	m^2	Measurement	
RLA_M	Relative mistletoe leaf area of a branch	%	Measurement	$RLA_M = \frac{LA_M}{TLA}$
RLA_P	Relative needle leaf area of a branch	%	Measurement	$RLA_P = \frac{LA_P}{TLA}$
CSA	Cross-sectional area of a branch	cm^2	Measurement	
$\Psi_{\text{Leaf M}}$	Mistletoe leaf water potential	MPa	Measurement	
$\Psi_{\text{Leaf P}}$	Pine needle leaf water potential	MPa	Measurement	
Rad	Net radiation	W m^{-2}	Measurement	
PAR	Photosynthetic active radiation	$\mu\text{mol m}^{-2} \text{s}^{-1}$	Measurement	
u_z	Wind speed	m s^{-1}	Measurement	

VPD	Vapour pressure deficit air	kPa	Measurement	
T	Air temperature	°C	Measurement	
C_a	Ambient CO ₂ concentration	ppm	Measurement	
Ψ_{Soil}	Soil water potential	MPa	Measurement	
ET_{Pot}	Potential branch evapotranspiration	g h^{-1}	HPMZ07	
TE	Total branch transpiration	g h^{-1}	HPMZ07	$TE = E_M + E_P$
E_M	Transpiration mistletoes	g h^{-1}	HPMZ07	
E_P	Transpiration pine needles	g h^{-1}	HPMZ07	
RE_M	Relative mistletoe transpiration of a branch	%	HPMZ07	$RE_M = \frac{E_M}{TE}$
RE_P	Relative needle transpiration of a branch	%	HPMZ07	$RE_P = \frac{E_P}{TE}$
Tg_s	Total leaf conductance branch	$\text{mg MPa}^{-1} \text{s}^{-1}$	HPMZ07	
$g_s \text{ M}$	Leaf conductance mistletoes	$\text{mg MPa}^{-1} \text{s}^{-1}$	HPMZ07	
$T\theta$	Total branch stomatal aperture	%	HPMZ07	$T\theta = \theta_M + \theta_P \leq 1$
θ_M	Stomatal aperture mistletoes	%	HPMZ07	
θ_P	Stomatal aperture pine	%	HPMZ07	
P_{Crown}	Crown water content	g	HPMZ07	
P_{Stem}	Stem water content	g	HPMZ07	
C_{Crown}	Crown water storage capacitance	g MPa^{-1}	HPMZ07	
C_{Stem}	Stem water storage capacitance	g MPa^{-1}	HPMZ07	
Ψ_{Crown}	Crown water potential	MPa	HPMZ07	
Ψ_{Bark}	Bark water potential	MPa	HPMZ07	
Ψ_{Root}	Root water potential	MPa	HPMZ07	
F_x	Water flow rates	g h^{-1}	HPMZ07	
R_x	Hydraulic flow resistances	MPa s mg^{-1}	HPMZ07	
$g_s \text{ P}$	Leaf conductance pine	$\text{mg MPa}^{-1} \text{s}^{-1}$	HPMZ07/ CAMH03	
A_P	Net carbon assimilation of pine	$\mu\text{mol m}^{-2} \text{s}^{-1}$	CAMH03	
T_L	Leaf temperature	°C	CAMH03	
$f(I)$	Light saturation curve	m s^{-1}	CAMH03	
R	Leaf respiration	$\mu\text{mol m}^{-2} \text{s}^{-1}$	CAMH03	
C_a	CO ₂ concentration of the air	ppm	CAMH03	
HPMZ07	Hydraulic plant model			Zweifel <i>et al.</i> , 2007
CAMH03	Assimilation model for pine			Hari and Makela, 2003;

References

- Ache P, Bauer H, Kollist H, Al-Rasheid KAS, Lautner S, Hartung W, Hedrich R.** 2010. Stomatal action directly feeds back on leaf turgor: new insights into the regulation of the plant water status from non-invasive pressure probe measurements. *The Plant Journal* **62**, 1072–1082.
- Adams HD, Guardiola-Claramonte M, Barron-Gafford GA, Villegas JC, Breshears DD, Zou CB, Troch PA, Huxman TE.** 2009. Temperature sensitivity of drought-induced tree mortality portends increased regional die-off under global-change-type drought. *Proceedings of the National Academy of Sciences, USA* **106**, 7063–7066.
- Bigler C, Braeker OU, Bugmann H, Dobbertin M, Rigling A.** 2006. Drought as inciting mortality factor in Scots pine stands of the Valais, Switzerland. *Ecosystems* **9**, 330–343.
- Buckley TN, Mott KA, Farquhar GD.** 2003. A hydromechanical and biochemical model of stomatal conductance. *Plant, Cell and Environment* **26**, 1767–1785.
- Ciais P, Reichstein M, Viovy N, et al.** 2005. Europe-wide reduction in primary productivity caused by the heat and drought in 2003. *Nature* **437**, 529–533.
- Cochard H.** 1992. Vulnerability of several conifers to air embolism. *Tree Physiology* **11**, 73–83.
- Cowan IR.** 1977. Stomatal behaviour and environment. *Advances in Botanical Research* **4**, 117–228.
- Cowan IR, Farquhar GD.** 1977. Stomatal function in relation to leaf metabolism and environment. *Symposium of the Society of Experimental Biology* **31**, 471–505.
- Dobbertin M, Eilmann B, Bleuler P, Giuggiola A, Pannatier EG, Landolt W, Schleppi P, Rigling A.** 2010. Effect of irrigation on needle morphology, shoot and stem growth in a drought-exposed *Pinus sylvestris* forest. *Tree Physiology* **30**, 346–360.
- Dobbertin M, Hilker N, Rebetz M, Zimmermann NE, Wohlgemuth T, Rigling A.** 2005a. The upward shift in altitude of pine mistletoe (*Viscum album* ssp. *austriacum*) in Switzerland: the result of climate warming? *Journal of Biometeorology* **50**, 40–47.
- Dobbertin M, Mayer P, Wohlgemuth T, Feldmeyer-Christie E, Graf U, Zimmermann N, Rigling A.** 2005b. The decline of *Pinus sylvestris* L. forests in the Swiss Rhone Valley: a result of drought stress? *Phyton* **45**, 153–156.
- Dobbertin M, Rigling A.** 2006. Pine mistletoe (*Viscum album* ssp. *austriacum*) contributes to Scots pine (*Pinus sylvestris*) mortality in the Rhone valley of Switzerland. *Forest Pathology* **36**, 309–322.
- Dobbertin M, Wermelinger B, Bigler C, Bürgi M, Carron M, Forster B, Gimmi U, Rigling A.** 2007. Linking increasing drought stress to Scots pine mortality and bark beetle infestations. *TheScientificWorldJOURNAL* **7**, 231–239.

- Eilmann B, Buchmann N, Siegwolf R, Saurer M, Cherubini P, Rigling A.** 2010. Fast response of Scots pine to improved water availability reflected in tree-ring width and $\delta^{13}\text{C}$. *Plant, Cell and Environment* **33**, 1351–1360.
- Eilmann B, Zweifel R, Buchmann N, Fonti P, Rigling A.** 2009. Drought-induced adaptation of the xylem in Scots pine and pubescent oak. *Tree Physiology* **29**, 1011–1020.
- Eilmann B, Zweifel R, Buchmann N, Graf Pannatier E, Rigling A.** 2011. Drought alters timing, quantity, and quality of wood formation in Scots pine. *Journal of Experimental Botany* **62**, 2763–2771.
- Escher P, Peuke AD, Bannister P, Fink S, Hartung W, Jiang F, Rennenberg H.** 2008. Transpiration, CO_2 assimilation, WUE, and stomatal aperture in leaves of *Viscum album* (L.): effect of abscisic acid (ABA) in the xylem sap of its host (*Populus×euamericana*). *Plant Physiology and Biochemistry* **46**, 64–70.
- Ewers BE, Mackay DS, Samanta S.** 2007. Interannual consistency in canopy stomatal conductance control of leaf water potential across seven tree species. *Tree Physiology* **27**, 11–24.
- Galiano L, Martinez-Vilalta J, Lloret F.** 2011. Carbon reserves and canopy defoliation determine the recovery of Scots pine 4 years after a drought episode. *New Phytologist* 1469–8137 doi: 10.1111/j.1469-8137.2010.03628.x, p 10.
- Glatzel G, Geils BW.** 2009. Mistletoe ecophysiology: host-parasite interactions. *Botany-Botanique* **87**, 10–15.
- Hari P, Makela A.** 2003. Annual pattern of photosynthesis in Scots pine in the boreal zone. *Tree Physiology* **23**, 145–155.
- Jackson GE, Irvine J, Grace J.** 1995. Xylem cavitation in two mature Scots pine forests growing in a wet and a dry area of Britain. *Plant, Cell and Environment* **18**, 1411–1418.
- Janssens IA, Sampson DA, Curiel-Yuste J, Carrara A, Ceulemans R.** 2002. The carbon cost of fine root turnover in a Scots pine forest. *Forest Ecology and Management* **168**, 231–240.
- Larcher W.** 2003. *Physiological plant ecology: ecophysiology and stress physiology of functional groups*. Berlin: Springer.
- Lawson T, James W, Weyers J.** 1998. A surrogate measure of stomatal aperture. *Journal of Experimental Botany* **49**, 1397–1403.
- Leuzinger S, Bigler C, Wolf A, Korner C.** 2009. Poor methodology for predicting large-scale tree die-off. *Proceedings of the National Academy of Sciences, USA* **106**, 106–106.
- Makela A, Hari P, Berninger F, Hanninen H, Nikinmaa E.** 2004. Acclimation of photosynthetic capacity in Scots pine to the annual cycle of temperature. *Tree Physiology* **24**, 369–376.
- Marshall JD, Dawson TE, Ehleringer JR.** 1994. Integrated nitrogen, carbon and water relations of a xylem-tapping mistletoe following nitrogen-fertilization of the host. *Oecologia* **100**, 430–438.
- Meinzer FC, Woodruff DR, Shaw DC.** 2004. Integrated responses of hydraulic architecture, water and carbon relations of western hemlock to dwarf mistletoe infection. *Plant, Cell and Environment* **27**, 937–946.
- Oberhuber W.** 2001. The role of climate in the mortality of Scots pine (*Pinus sylvestris* L.) exposed to soil dryness. *Dendrochronologia* **19**, 45–55.
- Poyatos R, Llorens P, Pinol J, Rubio C.** 2008. Response of Scots pine (*Pinus sylvestris* L.) and pubescent oak (*Quercus pubescens* Willd.) to soil and atmospheric water deficits under Mediterranean mountain climate. *Annals of Forest Science* **65**, 306.
- Rebetez M, Dobbertin M.** 2004. Climate change may already threaten Scots pine stands in the Swiss Alps. *Theoretical and Applied Climatology* **79**, 1–9.
- Reblin JS, Logan BA, Tissue DT.** 2006. Impact of eastern dwarf mistletoe (*Arceuthobium pusillum*) infection on the needles of red spruce (*Picea rubens*) and white spruce (*Picea glauca*): oxygen exchange, morphology and composition. *Tree Physiology* **26**, 1325–1332.
- Rigling A, Bräker O, Schneiter G, Schweingruber F.** 2002. Intra-annual tree-ring parameters indicating differences in drought stress of *Pinus sylvestris* forests within the *Erico-Pinion* in the Valais (Switzerland). *Plant Ecology* **163**, 105–121.
- Rigling A, Eilmann B, Koechli R, Dobbertin M.** 2010. Mistletoe-induced crown degradation in Scots pine in a xeric environment. *Tree Physiology* **30**, 845–852.
- Sala A.** 2009. Lack of direct evidence for the carbon-starvation hypothesis to explain drought-induced mortality in trees. *Proceedings of the National Academy of Sciences, USA* **106**, E68–E68.
- Schulze ED, Turner NC, Glatzel G.** 1984. Carbon, water and nutrient relations of two mistletoes and their hosts: an hypothesis. *Plant, Cell and Environment* **7**, 293–299.
- Sperry JS.** 2003. Evolution of water transport and xylem structure. *International Journal of Plant Sciences* **164**, S115–S127.
- Sterck FJ, Zweifel R, Sass-Klaassen U, Chowdhury Q.** 2008. Persisting soil drought reduces the leaf specific conductivity in Scots pine (*Pinus sylvestris* L.) and pubescent oak (*Quercus pubescens* Willd.). *Tree Physiology* **28**, 528–536.
- Tennakoon KU, Pate JS.** 1996. Effects of parasitism by a mistletoe on the structure and functioning of branches of its host. *Plant, Cell and Environment* **19**, 517–528.
- Vertui F, Tagliaferro F.** 1996. Scots pine die-back by unknown causes in the Aosta Valley, Italy. *Chemosphere* **36**, 1061–1065.
- Zha T, Kellomaki S, Wang KY, Rouvinen I.** 2004. Carbon sequestration and ecosystem respiration for 4 years in a Scots pine forest. *Global Change Biology* **10**, 1492–1503.
- Zuber D.** 2004. Biological flora of Central Europe: *Viscum album* L. *Flora* **199**, 181–203.
- Zweifel R, Böhm JP, Häslar R.** 2002. Midday stomatal closure in Norway spruce: reactions in the upper and lower crown. *Tree Physiology* **22**, 1125–1136.
- Zweifel R, Rigling A, Dobbertin M.** 2009. Species-specific stomatal response of trees to drought: a link to vegetation dynamics. *Journal of Vegetation Science* **20**, 442–454.
- Zweifel R, Steppe K, Sterck FJ.** 2007. Stomatal regulation by microclimate and tree water relations: interpreting ecophysiological field data with a hydraulic plant model. *Journal of Experimental Botany* **58**, 2113–2131.
- Zweifel R, Zeugin F.** 2008. Ultrasonic acoustic emissions in drought-stressed trees: more than signals from cavitation? *New Phytologist* **179**, 1070–1079.

Zweifel R, Zeugin F, Zimmermann L, Newbery DM. 2006. Intra-annual radial growth and water relations of trees: implications towards a growth mechanism. *Journal of Experimental Botany* **57**, 1445–1459.

Zweifel R, Zimmermann L, Newbery DM. 2005. Modeling tree water deficit from microclimate: an approach to quantifying drought stress. *Tree Physiology* **25**, 147–156.